

Technische Daten
Technical Data
Caractéristiques techniques

LR 1800

Raupenkran
Crawler Crane
Grue sur chenilles

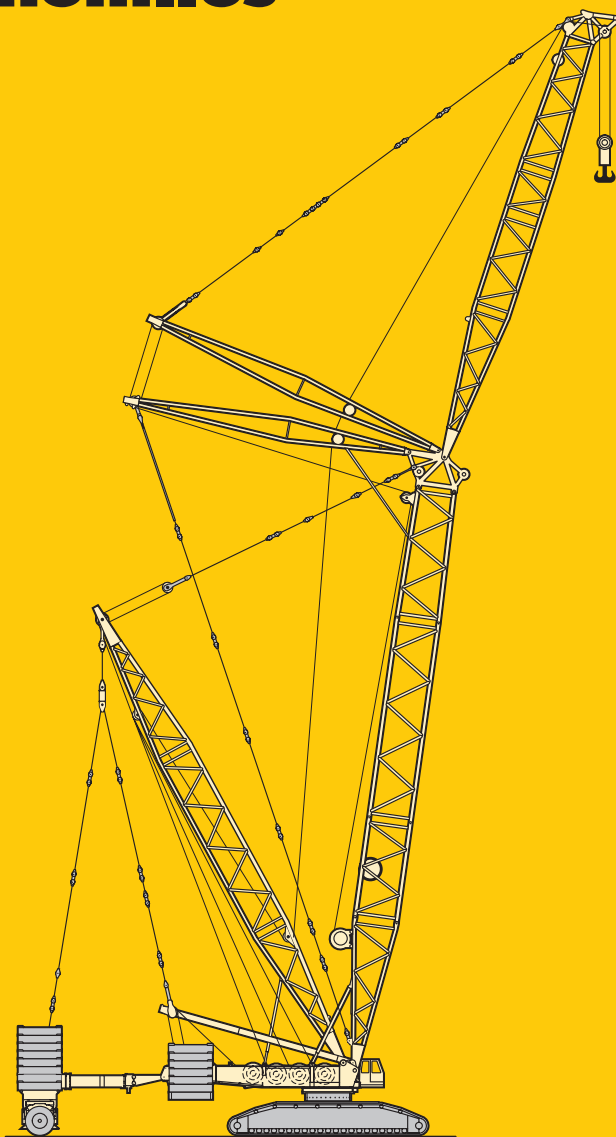

LIEBHERR

Inhaltsverzeichnis

Technische Beschreibung	4
Die Maße	7
Transportplan	8
Lastaufnahmemittel und Geschwindigkeiten	9
Die Auslegersysteme	10 – 11
Die Traglasten und Hubhöhen am L/LD/LDB/LDBW-Ausleger	12 – 17
Die Traglasten und Hubhöhen am SL-Auslegersystem	18 – 20
Die Traglasten und Hubhöhen am S/SD/SDB/SDBW-Auslegersystem	21 – 27
Die Traglasten und Hubhöhen am SDW/SDWB/SDWBW-Auslegersystem	28 – 38
Die Traglasten und Hubhöhen am SDWVBW-Auslegersystem	39 – 40

Table of content

Technical description	5
Dimensions	7
Transportation plan	8
Hook blocks and hooks, working speeds	9
Boom/jib combinations	10 – 11
Lifting capacities and heights on L/LD/LDB/LDBW boom/derrick combination	12 – 17
Lifting capacities and heights on SL boom/derrick combination	18 – 20
Lifting capacities and heights on S/SD/SDB/SDBW boom/derrick combination	21 – 27
Lifting capacities and heights on SDW/SDWB/SDWBW boom/derrick/jib combination	28 – 38
Lifting capacities and heights on SDWVBW combination	39 – 40

Tables des matières

Description technique	6
Les dimensions	7
Plan de transport	8
Organes de préhension et vitesses	9
Les configurations de flèche	10 – 11
Les forces de levage et hauteurs de levage à la flèche principale L/LD/LDB/LDBW	12 – 17
Les forces de levage et hauteurs de levage à la flèche principale SL	18 – 20
Les forces de levage et hauteurs de levage en configuration S/SD/SDB/SDBW	21 – 27
Les forces de levage et hauteurs de levage en configuration SDW/SDWB/SDWBW	28 – 38
Les forces de levage et hauteurs de levage en configuration SDWVBW	39 – 40

Raupenfahrwerk.

Rahmen:	Eigengefertigte, verwindungssteife Kastenkonstruktion aus hochfestem Feinkorn-Baustahl bestehend aus Raupenmittelteil, zwei Querträgern und zwei Raupenträgern.
Laufwerk:	Wartungsfreies, schmutzgeschütztes Raupenfahrwerk mit 1,5 m (2,0 m als Option) breiten Bodenplatten und Zentralschmieranlage für Turas- und Laufrollenlagerung.
Fahrtrieb:	Pro Raupenträger 2 hydraulische Fahrtriebe bestehend aus Axialkolben-Verstellmotor, Planetengetriebe mit federbelasteter, hydraulisch löfbarer Fahrwerksbremse und Turas. Die Raupenkettens sind synchron sowie unabhängig und gegenläufig zueinander steuerbar.
Zentralballast:	32 t, bestehend aus 2 Grundplatten á 16 t.

Kranoberwagen.

Rahmen:	Eigengefertigte, verwindungssteife Schweißkonstruktion aus hochfestem Feinkorn-Baustahl. Verbindung zum Raupenfahrwerk über 3-reihige Rollendrehverbindung, 360° unbegrenzt schwenkbar.
Kranmotor:	12-Zylinder-Turbo-Diesel, Fabrikat DaimlerChrysler, Typ OM 444 LA, wassergekühlt, Leistung nach DIN 605 kW (823 PS) bei 1900 min ⁻¹ , max. Drehmoment 3260 Nm bei 1000 - 1600 min ⁻¹ . Kraftstoffbehälter 1200 l.
Krantrieb:	Diesel-hydraulisch über Pumpenverteilergetriebe mit 6 Axialkolben-Verstellpumpen mit Leistungsregelung, geschlossene Ölkreisläufe.
Kransteuerung:	Servosteuerung mit elektronischer Gleichlaufeinrichtung über drei 4fach Kreuzsteuerhebel und zwei 2fach Steuerhebel. Stufenlose Regulierung der Kranbewegungen durch Verstellen der Hydraulikpumpen und zusätzlich durch Veränderung der Dieselmotor-Drehzahl.
Winden 2, 3 und 4:	Hydraulisch angetriebene Seiltrommel über Axialkolben-Verstellmotor und Planetengetriebe mit federbelasteter, hydraulisch löfbarer Haltebremse. Verschleißfreie Bremsung beim Senkvorgang über geschlossene Ölkreisläufe. Winde 2 - Hubwerk, Winde 3 - Hubwerk, Winde 4 - Einziehwerk Hilfswinde zum Einscheren von Seilen.
Drehwerk:	1 Drehwerk (2 bzw. 3 als Option), hydraulisch angetrieben über Axialkolben-Verstellmotor und Planetengetriebe mit federbelasteter, hydraulisch löfbarer Haltebremse. Verschleißfreie Bremsung über geschlossene Ölkreisläufe.
Krankabine:	Großräumige Kabine in Stahlblechausführung, nach hinten neigbar, mit Bedienungs- und Kontrollinstrumenten und motorunabhängiger Warmwasserheizung (Klimaanlage als Option).
Sicherheitseinrichtungen:	PAT-Überlastanlage, Hubendbegrenzung, elektronische Neigungsanzeige, Sicherheitsventile gegen Rohr- und Schlauchbrüche, Windmesser.
Elektrische Anlage:	24 V Gleichstrom, 2 Batterien á 170 Ah.
Drehbühnenballast:	162 t, bestehend aus Grundplatte 10 t und 8 Platten á 19 t.

Auslegersystem.

L - Hauptausleger:	L 21 - 112 m, System 3124.10.
SL - Hauptausleger:	SL 28 - 98 m, System 3729.10 / 3124.10.
S - Hauptausleger:	S 42 - 126 m (S 91 m - 126 m nur mit Derrick), System 3729.10.
D - Derrickausleger:	D 42 m, System 3124.10.
W - Wippbare Gitterspitze:	W 35 - 91 m, System 3124.10.
B - Schwebeballast:	Schwebeballastpalette mit Ausgleichszylinder und mechanischer Führung für max. 450 t Derrickballast bei max. 25 m Gegenausladung.
BW - Ballastwagen:	Ballastwagen mit Ausgleichszylinder und hydraulisch teleskopierbarer Führung für max. 450 t Derrickballast bei max. 25 m Gegenausladung.

Zusatzausrüstung.

Winden 1, 5 und 6:	Winde 1 - Verstellung Hauptausleger/D-Betrieb, Winde 5 - Verstellung wippbare Gitterspitze, Winde 6 - Zusatzhubwerk.
Ballast:	Zentralballast 142 t, zusätzlich 110 t. Drehbühnenballast 238 t, zusätzlich 76 t. Schwebeballast B 450 t, 20 t Grundrahmen und 430 t Ballast. Ballastwagen BW 450 t, 50 t Ballastwagen und 400 t Ballast.
Mechanische Zusatzabstützung:	Zum Aufrichten langer Auslegerkombinationen ohne Derrickballast.
Hydraulische Montageabstützung:	Zum Anheben des Grundgerätes bei Montage/Demontage.
Mobile Bolzenzieheinrichtung:	Zur Montage/Demontage der Ausleger-Zwischenstücke.
Quick Connection:	Schnellverbindung zum leichten Trennen von Kranoberwagen und Raupenfahrwerk.
Mastnasen:	Mastnase 60 t mit Adapter.

Die Auslegersysteme.

Leichte Ausführung:	L - LD - LDB - LDBW
Schwere Ausführung:	S - SD - SL - SDB - SDBW - SDW - SDWB - SDWBW - SDWVBW

Weitere Zusatzausrüstungen auf Anfrage.

Crawler travel gear.

Frame:	Self-manufactured, torsion-resistant box-type design of high-tensile grain refined structural steel, comprising crawler centre section, two cross girders and two crawler carriers.
Travel gear:	Maintenance-free, dirt-protected crawler travel gear with 1,5 m (2,0 m optional) track pads and centralized lubrication system for tumbler and track roller bearings.
Travel drive:	2 hydraulic travel drives per crawler carrier, comprising axial piston variable displacement motor, planetary gear with spring-loaded, hydraulically releasable travel brake and tumbler. The crawler chains are controllable synchronously, independently and opposed to one another.
Central ballast:	32 t, consisting of 2 base slabs 16 t each.

Crane superstructure.

Frame:	Self-manufactured, torsion-resistant weldment of high-tensile grain refined structural steel. Connected to crawler travel gear by a 3-row roller slewing rim for 360° continuous rotation.
Crane engine:	12-cylinder turbo-charged Diesel engine, make DaimlerChrysler, type OM 444 LA, water-cooled, output acc. to DIN 605 kW (823 h.p.) at 1900 min ⁻¹ , max. torque 3260 Nm at 1000 – 1600 min ⁻¹ , fuel reservoir 1200 l.
Crane drive:	Diesel-hydraulic by pump distribution gear with 6 axial piston variable displacement pumps with capacity control within closed oil circuits.
Crane control:	Servo-control with electronic synchronizing device by two four-way control levers and two two-way control levers (joy-stick type). Continuous control of the crane motions by variation of the hydraulic pumps, additionally by variation of the Diesel engine speed.
Winches 2, 3 and 4:	Hydraulically driven cable drums by axial piston variable displacement motor and planetary gear with spring-loaded, hydraulically releasable static brake. Wearfree braking function during lowering by closed oil circuits. Winch 2 – hoist gear, Winch 3 – hoist gear, winch 4 – derrick gear. Additional auxiliary winch for reeving of cables.
Slewing gear:	1 slewing gear (optionally 2 or 3), hydraulically powered by axial piston variable displacement motors and planetary gear with spring-loaded, hydraulically releasable static brake. Wearfree braking function by closed oil circuits.
Crane cabin:	Spacious sheet-metal cabin, tiltable to the rear, with operating and control instruments and self-contained warm water heater (optional air conditioning system).
Safety devices:	PAT safe-load indicator, hoist limit switches, electronic inclinometer, safety valves for the prevention of tube and hose ruptures, anemometer.
Electrical system:	24 V DC, 2 batteries 170 Ah each.
Superstructure ballast:	162 t, comprising basic slab of 10 t and 8 slabs of 19 t each.

Boom system.

L – Main boom:	L 21 – 112 m, system 3124.10.
SL – Main boom:	SL 28 – 98 m, system 3729.10 / 3124.10.
S – Main boom:	S 42 – 126 m (S 91 m – 126 m only with Derrick), system 3729.10.
D – Derrick boom:	D 42 m, system 3124.10.
W – luffing fly jib:	W 35 – 91 m, system 3124.10.
B – suspended ballast:	Suspended ballast pallet with compensating ram and mechanical control for max. 450 t derrick ballast at max. 25 m counter-radius.
BW – Ballast trailer:	Ballast trailer with compensating ram and hydraulic telescoping guide for max. 450 t derrick ballast at max. 25 m counter-radius.

Optional equipment.

Winches 1, 5 and 6:	Winch 1 – derricking main boom/D-operation, winch 5 – derricking luffing fly jib, winch 6 – auxiliary hoist gear.
Ballast:	Central ballast 142 t, additionally 110 t. Superstructure ballast 238 t, additionally 76 t. Suspended ballast B 450 t, 20 t suspended ballast pallet and 430 t ballast. Ballast trailer BW 450 t, 50 t ballast trailer and 400 t ballast.
Additional Mechanical supports:	For the erection of longer boom combinations without derrick ballast.
Hydraulic mounting supports:	For raising the basic machine during assembly/disassembly.
Portable pin pulling device:	For the assembly/disassembly of boom intermediate sections.
Quick Connection:	Rapid coupling system to facilitate dismounting the crane superstructure from the crawler travel gear.
Whip line:	Whip line 60 t with adapter.

Boom configurations.

Light-weight design:	L – LD – LDB – LDBW
Heavy-weight design:	S – SD – SL – SDB – SDBW – SDW – SDWB – SDWBW – SDWVBW

Further equipment items on request.

Train de chenilles.

Châssis:	Structure en caisson résistante à la torsion, fabriquée par Liebherr, en acier à grain fin très résistant, composée de la partie centrale, de deux traverses et de deux longerons.
Train de chenilles:	Train de chenilles ne nécessitant pas d'entretien et protégé contre les impuretés, équipé de tuiles de 1,5 m de large (2,0 m en option) et d'un dispositif de graissage centralisé pour les paliers des barbotins et des galets de roulement.
Transmission:	
Contrepoids central:	32 t, comprenant 2 plaques de base de 16 t.

Partie tournante.

Châssis:	Fabrication Liebherr, construction soudée indéformable, en acier grain fin à haute résistance. Liaison par couronne d'orientation à triple rangée de rouleaux, orientation illimitée à 360°.
Moteur de la grue:	
Entraînement de grue:	Entraînement Diesel hydraulique via un mécanisme de distribution de pompes avec 6 pompes à débit variable à pistons axiaux, avec réglage de la puissance en circuits hydrauliques fermés.
Commande de la grue:	Servo-commande avec dispositif de synchronisation électronique, via 4 manipulateurs en croix et 3 manipulateurs à deux positions. Commande des mouvements de la grue en continu, par régulation du débit des pompes et du régime du moteur Diesel.
Treuil 2, 3 et 4:	Tambour de câble à entraînement hydraulique, via un moteur à pistons axiaux à cylindrée variable, un train planétaire avec frein à ressort piloté hydrauliquement. Frein quasi-inusable via des circuits hydrauliques fermés pour les, mouvements de descente. Treuil 2 - Treuil de levage, Treuil 3 - Treuil de levage, Treuil 4 - Mécanisme de relevage. Supplémentaire treuil auxiliaire pour le mouflage des câbles.
Mécanisme d'orientation:	1 mécanisme d'orientation (2 ou 3 en option), à entraînement hydraulique via un moteur à pistons axiaux à cylindrée variable et un train planétaire avec frein à ressort et piloté hydrauliquement. Frein quasi-inusable via des circuits hydrauliques fermés.
Cabine du grutier:	Cabine spacieuse en tôle électrozinguée, inclinable vers l'arrière, avec instruments de commande et de contrôle et chauffage à eau chaude indépendant du moteur (climatisation en option).
Dispositifs de sécurité:	Contrôleur de charge PAT, limiteur de fin de course, inclinomètre électronique, clapets de sécurité contre les ruptures de tuyaux et de flexibles, anémomètre.
Installation électrique:	24 V en continu, 2 batteries de 170 Ah chacune.
Contrepoids de la partie tournante:	162 t, composé d'une plaque de base de 10 t et de 8 plaques de 19 t.

Systèmes de flèches.

Flèche principale L:	L 21 - 112 m, système 3124.10.
Flèche principale SL:	SL 28 - 98 m, système 3729.10 / 3124.10.
Flèche principale S:	S 42 - 126 m (S 91 m - 126 m uniquement avec Derrick), système 3729.10.
Flèche Derrick D:	D 42 m, système 3124.10.
Fléchette treillis à volée variable W:	W 35 - 91 m, système 3124.10.
Contrepoids suspendu B:	Palette du contrepoids suspendu avec vérin de guidage et système de guidage mécanique pour un contrepoids Derrick max. de 450 t et une contreportée max. de 25 m.
Chariot support de contrepoids BW:	Chariot support de contrepoids avec vérin de guidage et poutre de télescopage de contrepoids, pour un contrepoids Derrick de 450 t maximum et une contre-portée maximale de 25 m.

Equipement additionnel.

Treuil 1, 5 et 6:	Treuil 1 - treuil de manoeuvre de la flèche principale/Fonctionnement D. Treuil 5 - treuil de manoeuvre de la fléchette treillis à volée variable, Treuil 6 - treuil de levage.
Contrepoids:	Contrepoids central de 142 t, plus 110 t. Contrepoids de la partie tournante de 238 t, plus 76 t. Contrepoids suspendu B 450 t, cadre de base de 20 t et contrepoids de 430 t. Remorque à contrepoids BW 450 t, remorque à contrepoids de 50 t et contrepoids de 400 t.
Stabilisateurs mécaniques supplémentaires:	Pour le relevage des combinaisons de flèches longues sans contrepoids Derrick.
Stabilisateurs de montage hydrauliques:	Pour le levage de la machine de base lors du montage / démontage.
Dispositif d'extraction d'axes mobile:	Pour le montage / démontage des éléments intermédiaires de la flèche.
Raccord rapide:	Raccord rapide permettant de désolidariser facilement la partie tournante du train de chenilles.
Poulies brin simple:	Poulie brin simple de 60 t avec adaptateur.

Systèmes de flèches.

Conception légère:	L - LD - LDB - LDBW
Conception lourde:	S - SD - SL - SDB - SDBW - SDW - SDWB - SDWBW - SDWVBW
Autres équipements additionnels à la demande.	

Die Maße. Dimensions. Encombrement.

LR 1800

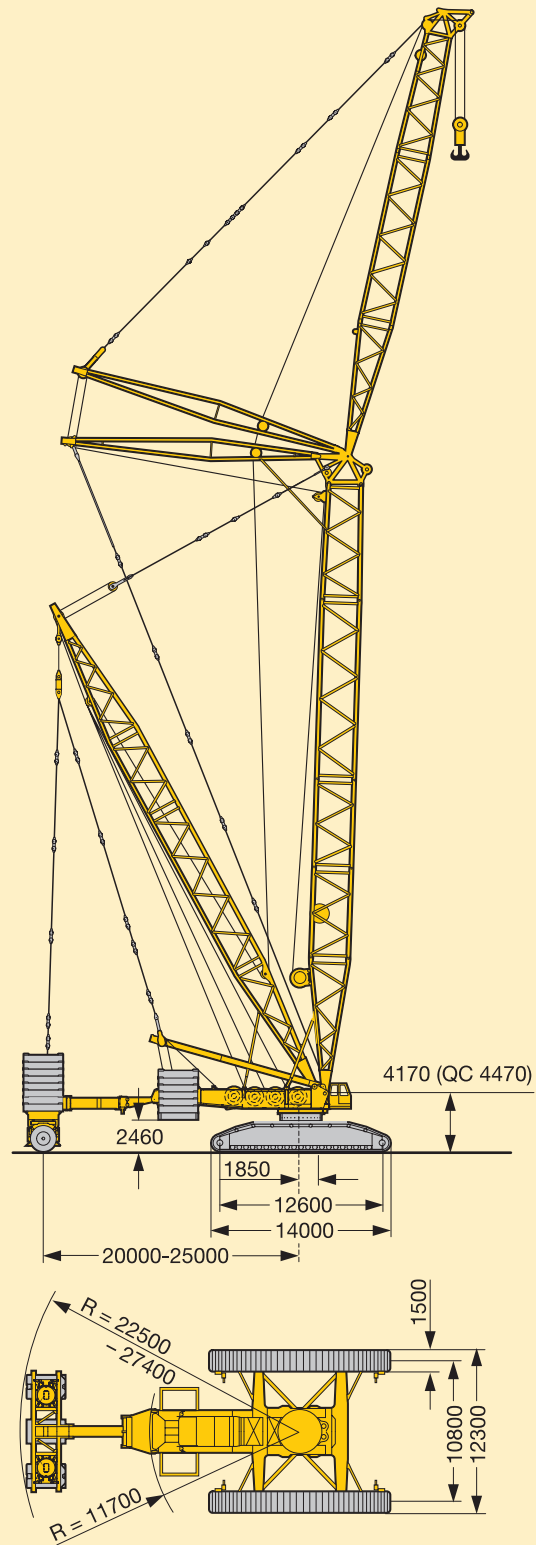

S 1003

Transportplan. Transportation plan. Plan de transport.

Drehbühne / Superstructure / Partie tournante

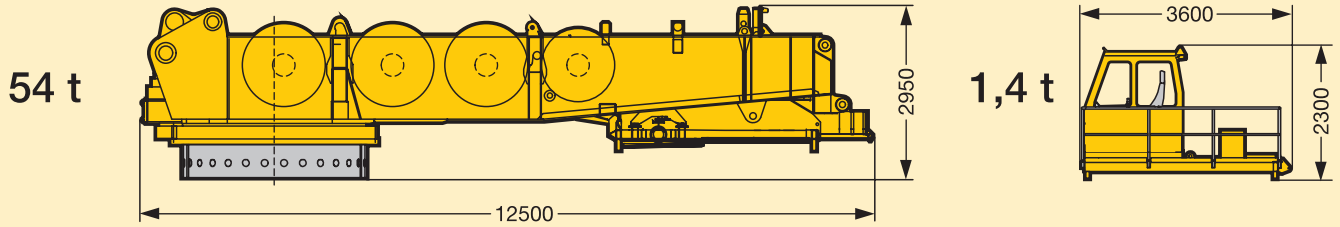

Raupenmittelteil / Crawler center frame / Partie centrale

1) mit Quick Connection
with Quick Connection
avec Quick Connection



SA-Bock mit Winde / SA-frame with winch / Chevalet SA avec treuil

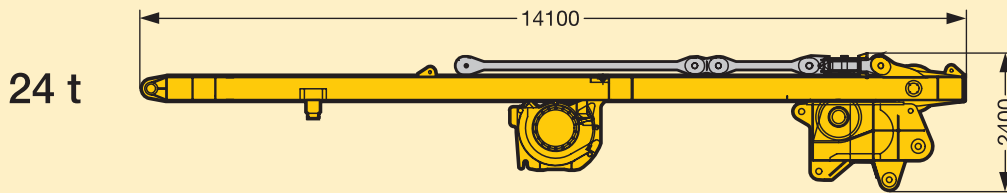

Querträger / Lateral beam / Poutre transversale

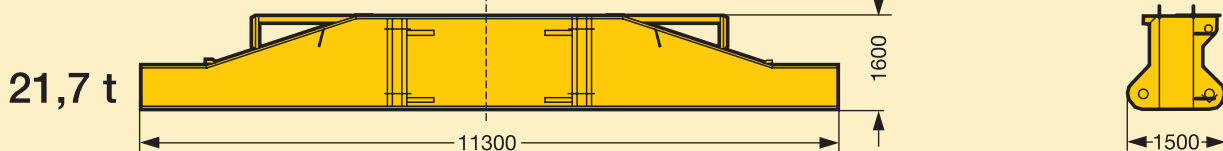

Raupenträger / Crawler carrier / Porteur chenilles

2) Plattenbreite 2 m
Width of plates 2 m
Patins dirne largeur de 2 m

Bodenplatten / Track pads / Pains de chenille

1,5 m	2 m
42 t	59 t

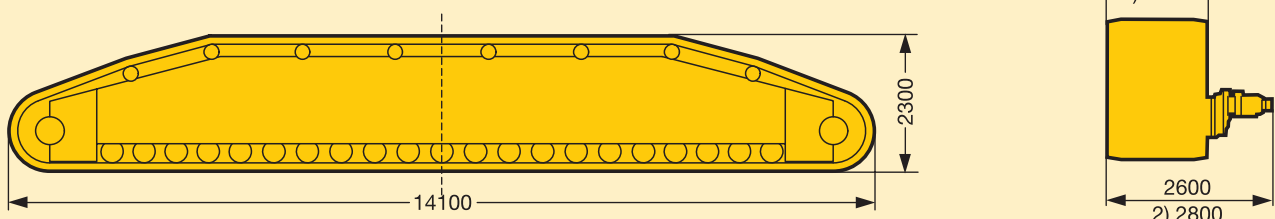

Die Lastaufnahmemittel. Hook blocks and hooks. Organes de préhension.

LR 1800

Traglasten (t) Load (t) Forces de levage (t)	Rollen No. of sheaves Poulies	Stränge No. of lines Brins	Gewicht (t) Weight (t) Poids (t)
800	2 x 12	2 x 24	20,3
520	2 x 7	2 x 15	12,1
400	12	25	12
260	7	15	9
140	3	7	6
60	1	3	4
20	-	1	1,4

Die Geschwindigkeiten. Working speeds. Vitesses.

Die Krangeschwindigkeiten bei Motordrehzahl 2100 min⁻¹.
Speeds of crane movements at max. engine speed of 2100 min⁻¹.
Vitesses de travail de la grue. Moteur à 2100 min⁻¹.

Antriebe Drive Entraînement	Winde I Winch I Treuil I	Winde II Winch II Treuil II	Winde III Winch III Treuil III	Winde IV Winch IV Treuil IV	Winde V Winch V Treuil V	Winde VI Winch VI Treuil VI
Geschwindigkeiten Speeds Vitesses	0 – 106 m/min	0 – 106 m/min	0 – 106 m/min	2 x 0 – 30 m/min	0 – 106 m/min	0 – 106 m/min
Max. Seilzug Max. rope tension Effort maxi. sur brin	206 kN	206 kN	206 kN	2 x 235 kN	206 kN	206 kN
Seillänge Rope length Longueur du câble	1336 m	1000 m	1000 m	850 m	980 m	550 m
Seildurchmesser Rope diameter Diamètre du câble	32 mm	32 mm	32 mm	32 mm	32 mm	32 mm
Gewicht mit Seil Weight with rope Poids avec câble	12,2 t	12,8 t	12,9 t	-	10 t	12 t

Die Auslegersysteme. Boom/jib combinations. Configurations de flèche.

LR 1800

Leichte Ausführung.
Light weight design.
Conception légère.

L Hauptausleger, leicht
Main boom, light
Flèche principale, légère

W Nadelausleger, schwer
Luffing jib, heavy
Fléchette, lourde

D Derrickausleger
Derrick
Flèche derrick

B Schwebeballast
Suspended ballast
Lest suspendu

BW Ballastwagen
Ballast trailer
Porteur de lest

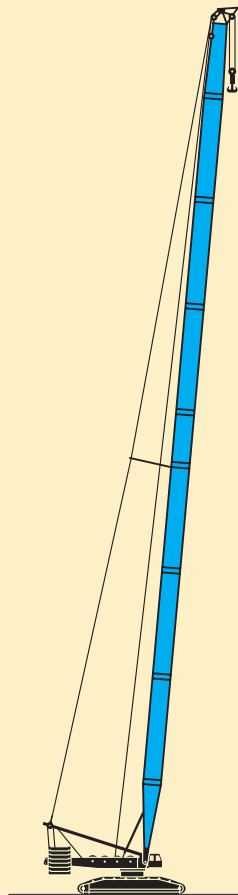

L

L 21 m - 112 m

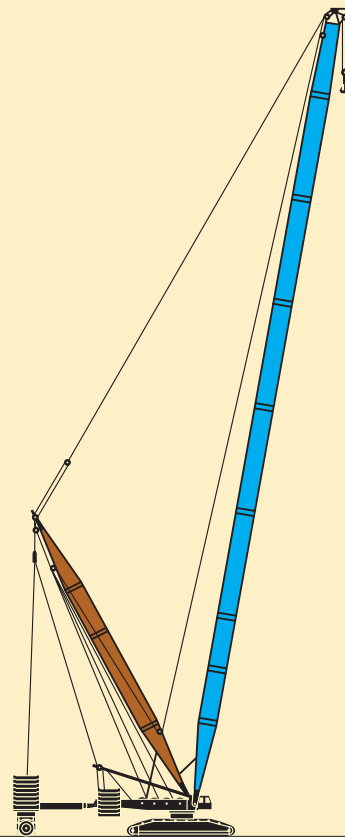

LD

LDB/BW

L 35 m - 105 m

D 42 m

S 1006

Die Auslegersysteme. Boom/jib combinations. Configurations de flèche.

LR 1800

Schwere Ausführung.
Heavy weight design.
Conception lourde.

- | | | | |
|----------|--|-----------|--|
| S | Hauptausleger, schwer
Main boom, heavy
Flèche principale, lourde | D | Derrickausleger
Derrick
Flèche derrick |
| L | Hauptausleger, leicht
Main boom, light
Flèche principale, légère | B | Schwebeballast
Suspended ballast
Lest suspendu |
| W | Nadelausleger, schwer
Luffing jib, heavy
Flèchette, lourde | BW | Ballastwagen
Ballast trailer
Porteur de lest |

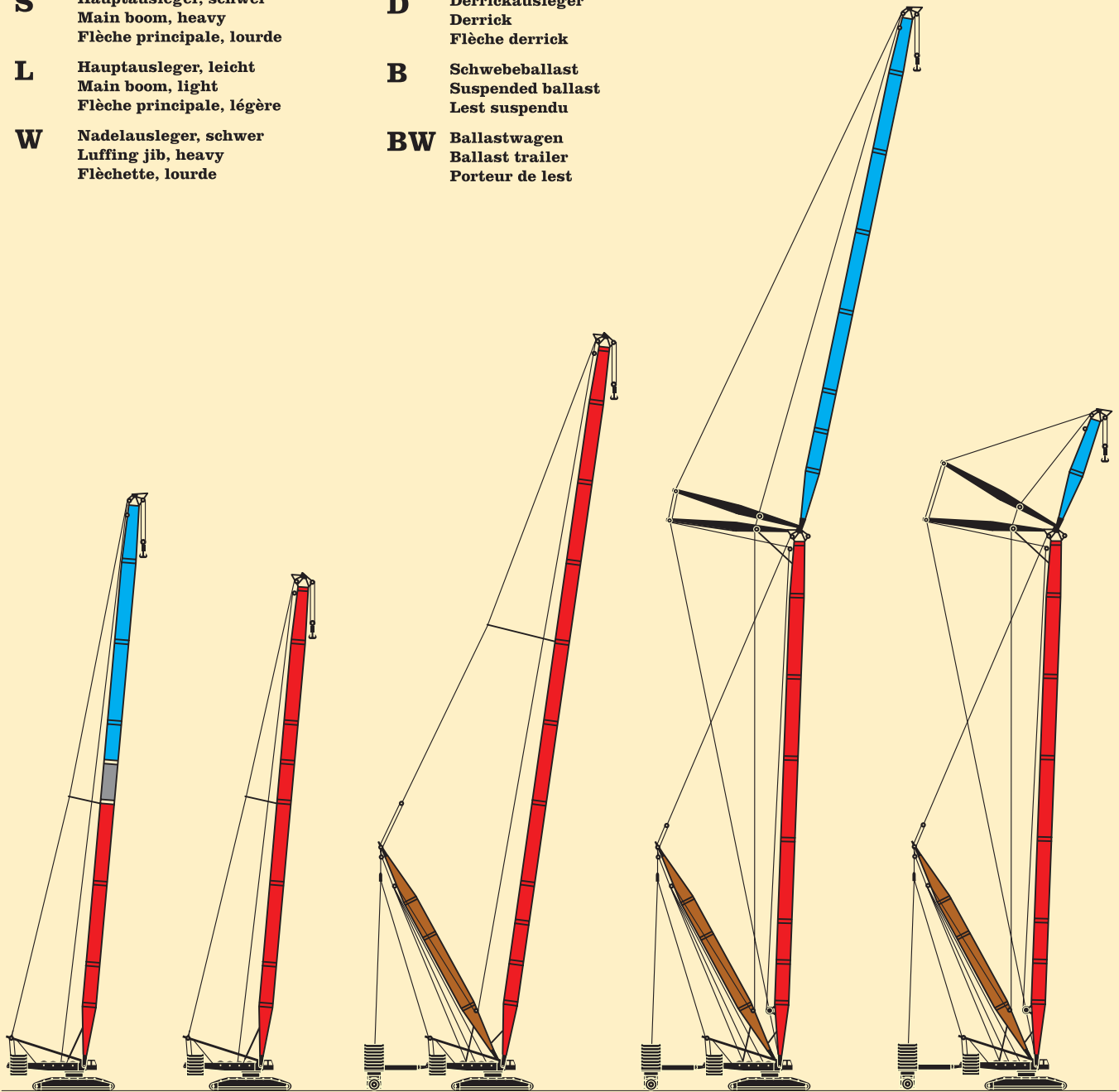

SL

SL 28 m - 98 m

S

S 42 m - 84 m

SD

SDB/BW

S 42 m - 126 m

D 42 m

SDW

SDWB/BW

S 49 m - 91 m

W 35 m - 91 m

D 42 m

SDWVBW

S 49 m - 91 m

WV 21 m

D 42 m

S 1010

Die Traglasten am L-Ausleger. Lifting capacities on L boom. Forces de levage à la flèche principale L.

LR 1800



21 m – 112 m



11,08 m x 10,8 m



360°



238 t

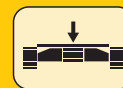

142 t

m	21 m	28 m	35 m	42 m	49 m	56 m	63 m	70 m	77 m	84 m	91 m	98 m	105 m	112 m	m
6	650														6
6,5	605														6,5
7	580	520													7
8	520	510	500												8
9	480	480	480	440	400	360									9
10	440	440	440	420	388	347	312	280							10
11	410	410	410	400	370	332	300	271	235	200					11
12	385	385	385	380	352	319	288	262	228	194	178	165			12
14	340	340	340	334	320	294	266	242	214	184	169	157	136	120	14
16	300	300	300	295	288	270	245	224	200	174	160	150	130	114	16
18	260	260	260	258	256	244	226	207	185	164	152	142	125	109	18
20	225	225	225	223	222	220	207	190	173	155	143	136	120	104	20
22		200	200	198	197	196	190	177	161	146	137	129	114	99	22
24		178	178	176	176	175	174	163	150	139	130	123	109	95	24
26		160	160	158	158	158	157	152	140	131	122	117	104	90	26
28			147	146	146	145	145	142	131	125	116	112	99	86	28
30			137	135	135	134	134	132	123	119	110	107	95	82	30
32			130	127	126	125	125	122	116	113	106	103	91	79	32
34				118	117	117	116	114	110	108	101	99	87	76	34
36				112	112	111	109	106	104	102	96	95	83	73	36
38				106	105	104	102	100	98	95	92	91	80	70	38
40					100	98	95	94	91	89	88	86	77	67	40
44					89	86	84	82	80	77	76	74	71	63	44
48						77	74	72	70	68	66	64	62	59	48
52							66	64	62	60	58	56	54	51	52
56							60	58	55	53	51	49	47	45	56
60								52	50	47	46	44	41	39	60
64									45	42	41	39	36	34	64
68									40	38	36	34	32	30	68
72										34	32	30	28	26	72
76											29	27	24	22	76
80												26	24	21	80
84													21	19	84
88														16	88
92														14	92
96														10	96

Traglasten über 520 t nur mit Zusatzausrüstung
Lifting capacities above 520 t only with special equipment
Forces de levage plus de 520 t seulement avec équipement supplémentaire

TAB 57185

Anmerkungen zu den Traglast- tabellen.

- Die angegebenen Traglasten überschreiten nicht 75 % der Kipplast.
- Für die Kranberechnungen gelten die DIN-Vorschriften lt. neuem Gesetz gemäß Bundesarbeitsblatt vom 2/85: Die Traglasten 75 % (Standicherheit) entsprechen DIN 15019, Teil 2. Für die Stahltragwerke gilt DIN 15018, Teil 3. Die bauliche Ausbildung des Krans entspricht DIN 15018, Teil 2 sowie der F.E.M.
- Die Traglasten sind in Tonnen angegeben.
- Das Gewicht des Lasthakens bzw. der Hakenflasche sowie der Anschlagmittel ist von den Traglasten abzuziehen.
- Die Ausladungen sind von Mitte Drehkranz gemessen.
- Die Aufstandsfläche muß eben und tragfähig sein.

Remarks referring to load charts.

- The tabulated lifting capacities do not exceed 75 % of the tipping load.
- When calculating crane stresses and loads, German Industrial Standards (DIN) are applicable, in conformity with new German legislation (published 2/85): the 75 % lifting capacities (stability margin) are as laid down in DIN 15019, part 2. The crane's structural steelwork is in accordance with DIN 15018, part 3. Design and construction of the crane comply with DIN 15018, part 2, and with F. E. M. regulations.
- Lifting capacities are given in metric tons.
- The weight of the hook blocks and hooks as well as of lifting tackle must be deducted from the lifting capacities.
- Working radii are measured from the slewing centreline.
- The subsoil must be even and of good bearing capacity.

Remarques relatives aux tableaux des charges.

- Les forces de levage indiquées ne dépassent pas 75 % de la charge de basculement.
- Conformément au nouveau texte de loi paru au bulletin fédéral de février 1985, les normes DIN ci-après sont appliquées pour les calculs relatifs à la grue: charges à 75 % suivant les prescriptions de la norme DIN 15019, 2ème partie. La norme DIN 15018, 3ème partie est appliquée pour les charpentes. La construction de la grue est réalisée conformément à la norme DIN 15018, 2ème partie, et aux règles de la F.E.M.
- Les forces de levage sont données en tonnes.
- Le poids des moufles et crochets ainsi que des élingues doit être soustrait des charges indiquées.
- Les portées sont calculées à partir de l'axe de rotation.
- Le sol doit être plat et résistant.

Sein größtes Lastmoment ist 12100 tm.

Die Hubhöhen am L-Ausleger.

Lifting heights on L boom.

Hauteur de levage à la flèche principale L.

LR 1800

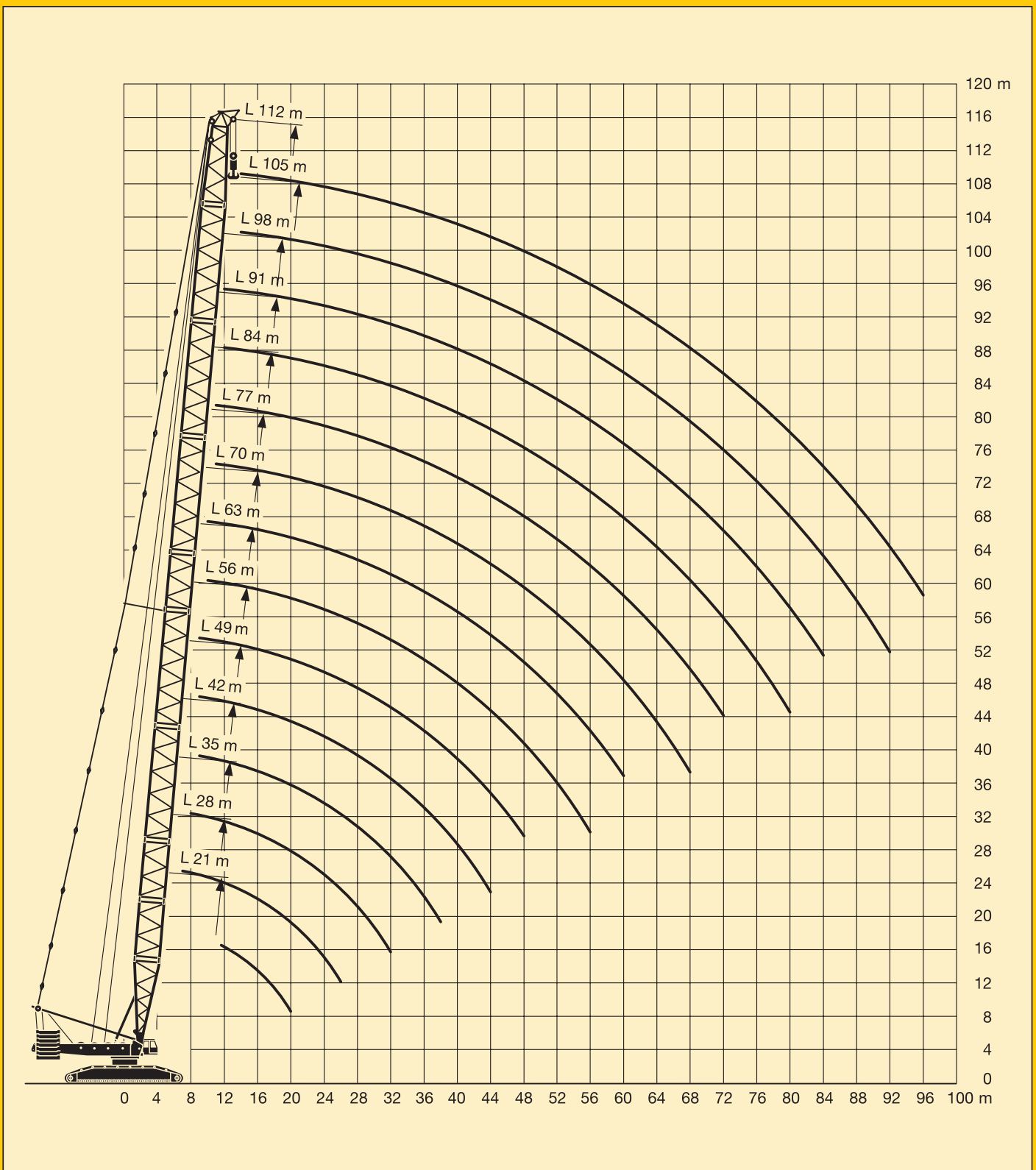

S 1013

Die Traglasten am LD-Auslegersystem.

LR 1800

Lifting capacities on LD boom/derrick combination.

Forces de levage en configuration LD.



35 m -
105 m



35 m -
42 m



11,08 m x
10,8 m





360°

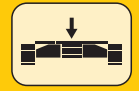

238 t



142 t

 m	35 m	42 m	49 m	56 m	63 m	70 m	77 m	84 m	91 m	98 m	105 m	 m
9	520											9
10	505	501										10
11	460	457										11
12	422	420	425									12
14	362	360	364	364	363							14
16	316	314	318	318	317	314						16
18	280	278	281	281	281	278	277	250				18
20	249	248	251	251	251	248	247	238	210	180		20
22	224	222	225	225	225	222	221	220	200	174	160	22
24	202	201	202	203	202	200	200	198	192	168	153	24
26	184	183	183	183	182	181	181	180	179	162	146	26
28	169	167	166	166	165	164	164	164	163	156	140	28
30	155	153	152	151	151	150	149	149	148	148	136	30
32	143	141	139	139	138	137	136	136	135	135	131	32
34		130	129	128	127	126	125	124	124	124	123	34
36		121	119	118	117	116	115	115	114	114	113	36
38		113	111	110	109	107	106	106	105	105	104	38
40			103	102	101	100	99	98	97	97	96	40
44			91	89	88	87	85	84	83	83	82	44
48				79	77	76	74	73	72	72	71	48
52					68	67	65	64	63	62	61	52
56					61	59	58	56	55	54	53	56
60						53	51	50	48	47	46	60
64							45	44	42	41	40	64
68							40	39	37	36	35	68
72								34	33	32	30	72
76									29	27	26	76
80									25	24	22	80
84										21	19	84
88											16	88
92											13	92

TAB 57240

Die Hubhöhen am LD-Auslegersystem. Lifting heights on LD boom/derrick combination. Hauteur de levage en configuration LD.

LR 1800

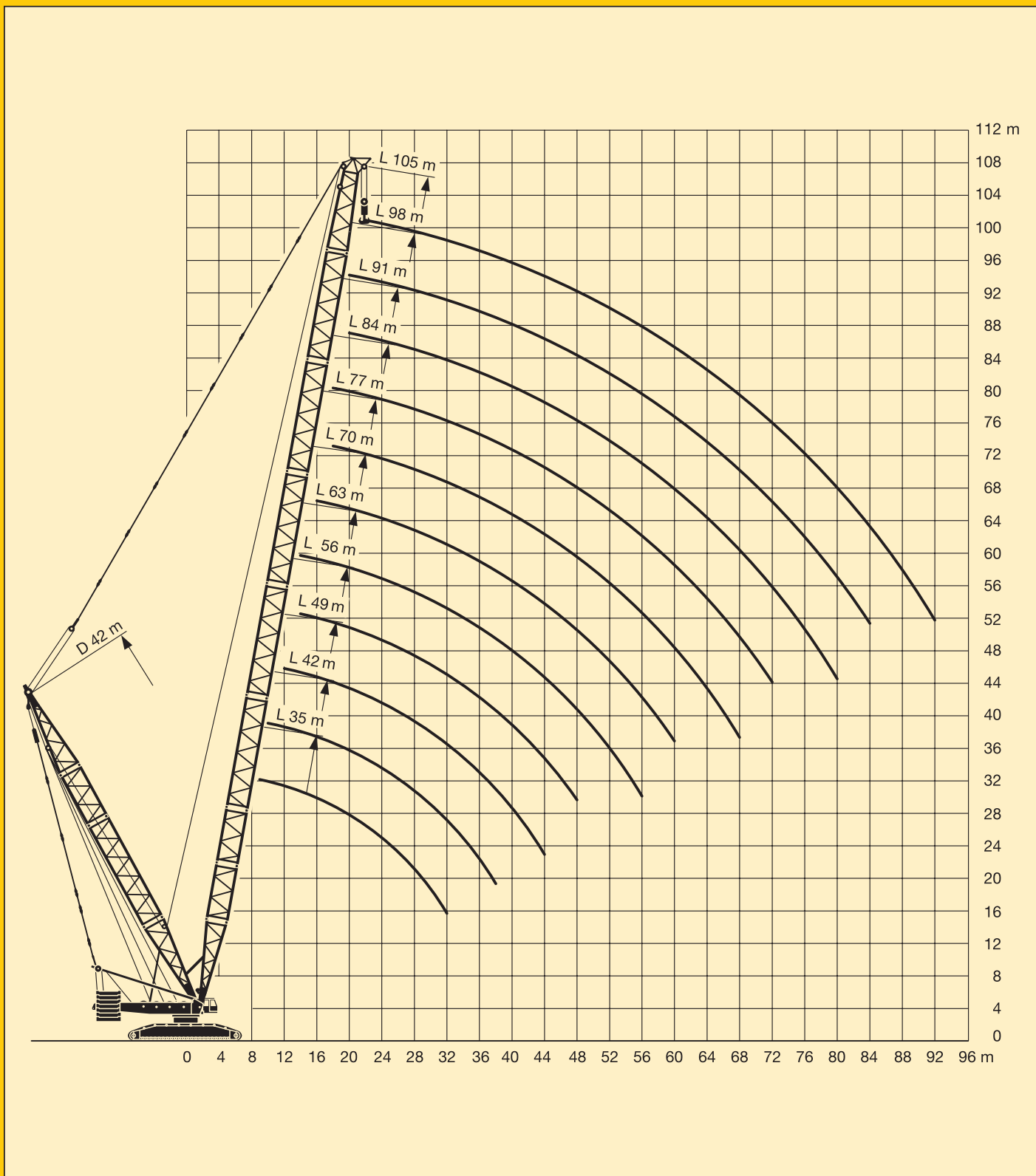

S 1008

Die Traglasten am LDB/LDBW-Auslegersystem. Lifting capacities on LDB/LDBW boom/derrick combination. Forces de levage en configuration LDB/LDBW.

LR 1800



35 m -
105 m



35 m -
42 m



11,08 m
x
10,8 m



360°





162 t

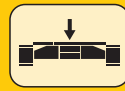

max.
400 t



32 t

 m	35 m ¹⁾	35 m	42 m	49 m	56 m	63 m	70 m	77 m	84 m	91 m	98 m	105 m	 m
9	750	520											9
10	710	520	510										10
11	670	520	503										11
12	635	520	497	480									12
14	570	520	485	470	419	370							14
16	520	520	473	460	407	354	324						16
18	510	510	461	450	396	341	310	290	250				18
20	496	496	449	440	384	328	298	276	238	210	180		20
22	465	465	436	430	373	317	286	265	228	200	174	160	22
24	410	410	425	417	362	306	276	256	219	192	168	153	24
26	364	364	411	401	351	296	266	246	211	185	162	146	26
28	323	323	370	385	339	286	258	238	204	178	156	140	28
30	286	286	334	371	326	277	249	231	197	172	151	136	30
32	253	253	302	358	313	268	241	223	190	166	146	131	32
34			273	335	300	259	234	216	184	160	141	126	34
36			247	313	286	251	226	210	179	156	137	121	36
38			222	290	275	242	219	204	173	150	133	117	38
40				266	262	234	212	198	168	146	129	113	40
44				222	237	219	199	186	158	138	121	105	44
48					213	203	186	175	148	129	113	98	48
52						188	173	164	140	122	106	91	52
56						174	161	154	131	114	99	85	56
60							150	144	122	105	92	78	60
64								135	114	100	86	72	64
68								125	106	94	80	66	68
72									99	88	74	61	72
76										82	68	55	76
80										76	63	50	80
84											57	45	84
88												40	88
92												35	92

¹⁾ Traglasten über 520 t nur mit Zusatzausrüstung
Lifting capacities above 520 t only with special equipment
Forces de levage plus de 520 t seulement avec équipement supplémentaire

TAB 57253

Its maximum load moment is 12100 tm.

Die Hubhöhen am LDB/LDBW-Auslegersystem. Lifting heights on LDB/LDBW boom/derrick combination. Hauteur de levage en configuration LDB/LDBW.

LR 1800

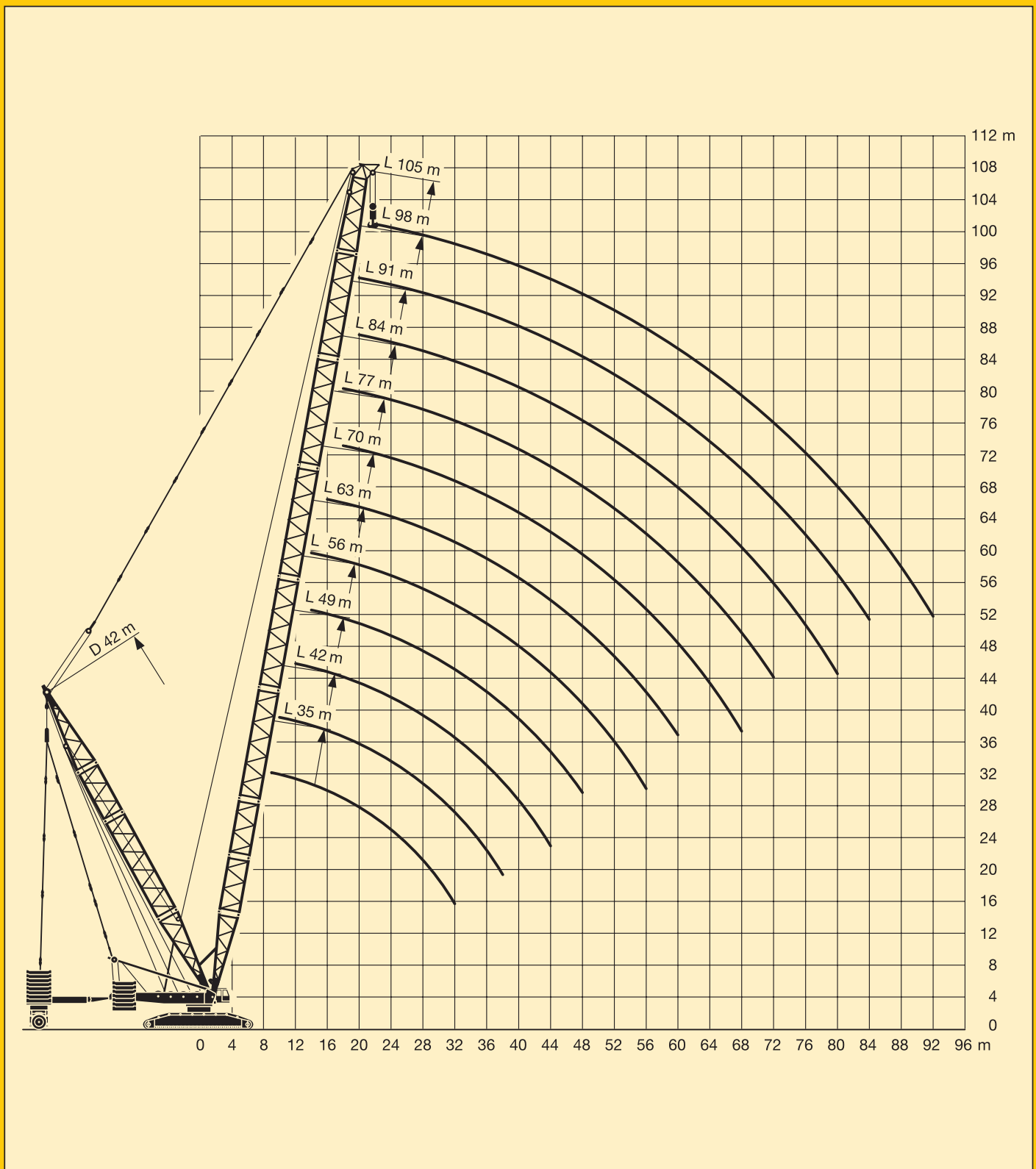

S 1016

Die Traglasten am SL-Ausleger.

Lifting capacities on SL boom.

Forces de levage à la flèche principale SL.

LR 1800



28 m – 98 m



11,08 m x 10,8 m





360°

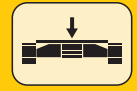

162 t



32 t

 m	28 m	35 m	42 m	49 m	56 m	63 m	70 m	77 m	84 m	91 m	98 m	 m
7	520											7
8	504	501										8
9	451	447	443	442	439							9
10	407	403	400	398	396	395	371					10
11	370	367	363	362	359	356	335	317	301			11
12	339	336	333	331	329	322	304	289	275	263	251	12
14	285	282	279	278	275	270	256	244	233	224	214	14
16	245	242	239	237	235	231	220	210	201	194	186	16
18	214	211	208	207	204	201	191	183	176	170	163	18
20	190	186	184	182	180	177	168	161	155	150	144	20
22	170	167	164	162	160	157	149	143	138	134	128	22
24	153	150	147	146	143	141	134	128	124	120	115	24
26	138	137	134	132	129	126	120	116	111	108	104	26
28		122	120	120	116	114	109	104	101	98	94	28
30		111	108	108	106	104	99	95	91	89	85	30
32		101	98	97	96	94	91	87	83	81	77	32
34			90	89	87	86	83	79	76	74	70	34
36			82	81	79	79	76	73	69	67	64	36
38			76	75	73	72	70	67	64	62	59	38
40				69	67	66	64	61	59	57	54	40
44				59	57	56	54	52	50	48	45	44
48					49	48	46	44	42	40	38	48
52						42	39	38	36	34	31	52
56							37	34	30	29	26	56
60								29	27	25	22	60
64									22	21	18	64
68									19	17	14	68
72										14	11	72
76											10	76
80											8	80

TAB 57216

Die Traglasten am SL-Ausleger.

Lifting capacities on SL boom.

Forces de levage à la flèche principale SL.

LR 1800



28 m – 98 m



11,08 m x 10,8 m



360°



238 t

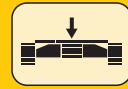

142 t

7 m	28 m	35 m	42 m	49 m	56 m	63 m	70 m	77 m	84 m	91 m	98 m	7 m
7	520											7
8	520	520										8
9	502	498	495	493	490							9
10	453	450	446	445	442	441	420					10
11	413	409	406	404	402	401	398	367	318			11
12	379	375	372	370	368	367	364	360	310	287	263	12
14	325	321	318	316	314	313	310	309	293	272	250	14
16	283	280	277	275	273	272	269	268	267	257	239	16
18	248	245	242	241	239	238	235	234	233	233	228	18
20	220	217	214	213	211	210	207	206	205	205	204	20
22	197	194	192	190	188	187	185	183	182	182	181	22
24	179	176	173	171	169	168	166	165	164	163	162	24
26	163	160	157	156	153	152	150	149	148	147	146	26
28		147	144	142	140	139	137	135	134	134	132	28
30		135	132	131	128	127	125	124	123	122	121	30
32		125	122	121	118	117	115	113	112	112	110	32
34			113	112	109	108	106	104	103	103	101	34
36			106	104	102	101	98	97	95	95	92	36
38			99	97	95	94	91	89	87	87	85	38
40				91	88	87	85	83	80	80	78	40
44				80	78	77	74	71	69	69	66	44
48					69	68	64	62	59	59	57	48
52						60	57	54	52	51	49	52
56						54	50	47	45	44	42	56
60							44	41	39	38	36	60
64								37	34	33	31	64
68								32	30	29	27	68
72									26	25	23	72
76										22	19	76
80										19	17	80
84											14	84

TAB 57219

Die Hubhöhen am SL-Ausleger. Lifting heights on SL boom. Hauteur de levage à la flèche principale SL.

LR 1800

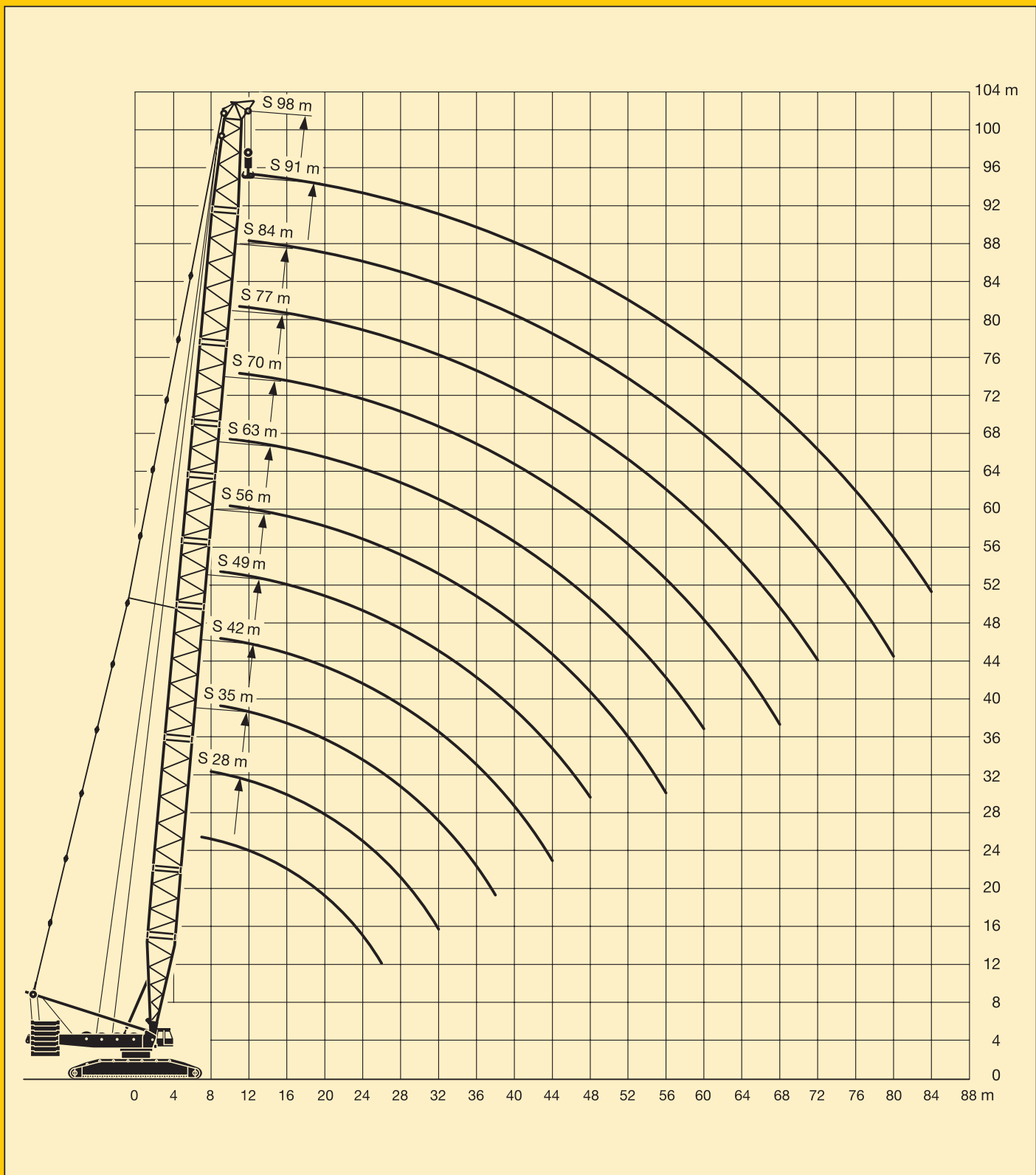

S 1000

Die Traglasten am S-Ausleger. Lifting capacities on S boom. Forces de levage à la flèche principale S.

LR 1800



42 m – 77 m



11,08 m x 10,8 m





360°

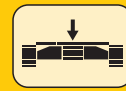

162 t



32 t

 m	42 m	49 m	56 m	63 m	70 m	77 m	 m
9	453	447	442				9
10	408	402	398	387	361		10
11	371	365	361	346	324	306	11
12	339	334	330	312	293	278	12
14	283	278	275	259	244	232	14
16	241	237	232	220	207	198	16
18	206	203	198	189	179	171	18
20	179	175	171	165	156	149	20
22	158	154	150	145	137	130	22
24	140	136	132	127	121	115	24
26	125	121	117	112	108	102	26
28	112	108	104	100	96	91	28
30	101	97	94	89	86	81	30
32	92	88	84	80	77	73	32
34	83	80	76	72	68	65	34
36	76	73	69	65	61	58	36
38	69	66	63	58	55	51	38
40		61	57	53	49	45	40
44		51	47	43	39	35	44
48			39	35	31	27	48
52				28	24	20	52
56				23	18	13	56
60					13	9	60
64						6	64

TAB 57220



42 m – 84 m



11,08 m x 10,8 m





360°

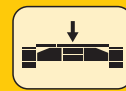

238 t



142 t

 m	42 m	49 m	56 m	63 m	70 m	77 m	84 m	 m
9	506	500	495					9
10	456	451	446	441	436			10
11	415	410	406	401	396	392	387	11
12	380	375	371	366	362	358	353	12
14	324	319	316	311	307	304	299	14
16	281	277	273	269	265	262	258	16
18	245	241	238	234	230	227	223	18
20	216	212	209	205	201	199	195	20
22	192	188	185	181	178	175	172	22
24	172	168	166	162	159	156	152	24
26	156	152	149	146	142	139	135	26
28	142	138	135	131	128	124	120	28
30	130	126	122	118	115	111	107	30
32	119	115	111	107	104	100	96	32
34	109	105	101	97	94	90	86	34
36	101	96	93	88	85	82	77	36
38	93	89	85	81	77	74	70	38
40		82	78	74	71	67	63	40
44		70	67	62	59	55	51	44
48			57	53	49	45	41	48
52				45	41	37	33	52
56				38	34	30	26	56
60					29	24	20	60
64						19	14	64
68						14	10	68
72							7	72

TAB 57223

Couple de charge maxi.: 12100 tm.

Die Hubhöhen am S-Ausleger.

Lifting heights on S boom.

Hauteur de levage à la flèche principale S.

LR 1800

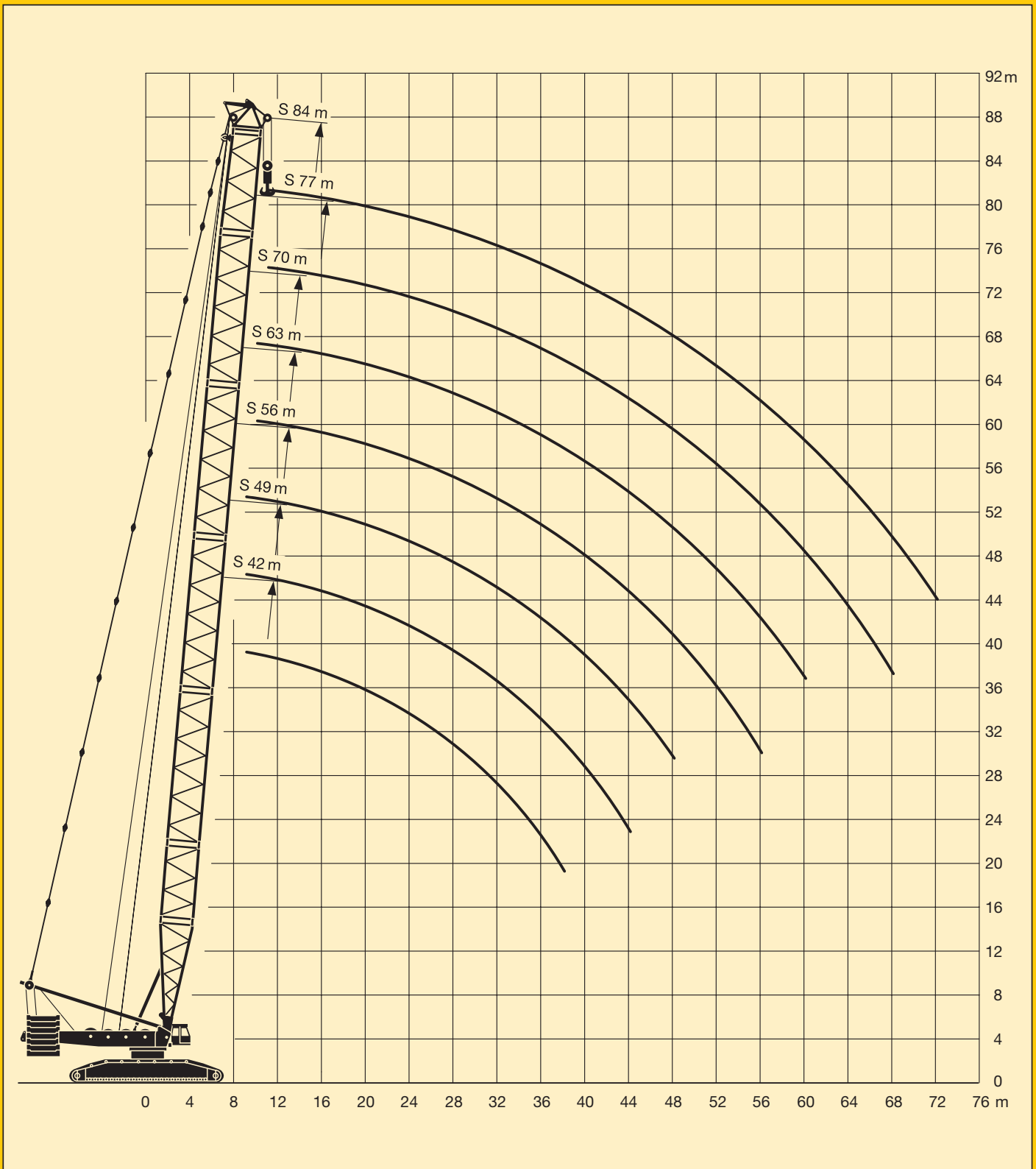

S 998

Die Traglasten am SD-Auslegersystem. Lifting capacities on SD boom/derrick combination. Forces de levage en configuration SD.

LR 1800



42 m - 98 m



35 m - 42 m



360°



162 t

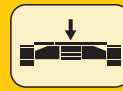

32 t

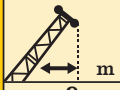
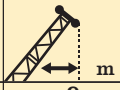
 m	42 m	49 m	56 m	63 m	70 m	77 m*	84 m*	91 m*	98 m*	 m
9	481									9
10	433	417	391	387	362					10
11	393	390	370	366	345	309	293			11
12	359	363	349	345	328	296	281	254		12
14	304	308	306	303	293	269	256	234	216	14
16	260	265	263	261	258	242	231	214	199	16
18	225	228	227	225	223	215	206	194	182	18
20	197	200	198	196	194	188	181	174	165	20
22	174	177	175	173	170	166	159	154	148	22
24	154	157	155	152	150	147	142	136	131	24
26	137	140	138	135	133	131	126	122	117	26
28	123	125	124	121	118	117	113	109	104	28
30	111	113	112	108	106	105	102	98	94	30
32	100	102	101	98	95	94	91	88	84	32
34	91	93	91	88	86	84	82	79	75	34
36	83	85	83	80	78	76	73	70	68	36
38	76	77	76	73	70	68	66	63	61	38
40		71	69	66	64	62	59	56	54	40
44		60	58	55	52	50	48	45	44	44
48			49	46	43	41	38	35	34	48
52				38	35	33	30	27	26	52
56				32	29	26	24	21	19	56
60					24	21	18	15	13	60
64						16	13	10	8	64
68						12	9	6		68
72							5			72

* nur aufrichtbar mit Derrickballast / raisable only with derrick ballast / seulement relevable avec contrepoids derrick

TAB 57390



42 m - 105 m



35 m - 42 m



360°



238 t

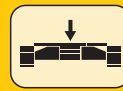

142 t

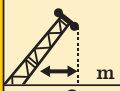
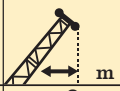
 m	42 m	49 m	56 m	63 m	70 m	77 m*	84 m*	91 m*	98 m*	105 m*	 m
9	535										9
10	481	464	433	431	401						10
11	437	434	410	408	383	357	355				11
12	400	404	387	385	365	342	340	314			12
14	340	344	341	339	328	312	310	290	276	273	14
16	294	297	295	293	291	282	280	266	255	252	16
18	258	261	258	256	254	252	250	242	234	231	18
20	229	231	229	227	225	222	220	218	213	210	20
22	203	206	204	202	200	198	196	194	192	189	22
24	182	183	181	180	179	176	175	173	171	168	24
26	164	163	161	160	160	158	156	154	153	150	26
28	148	146	145	143	143	140	139	137	135	132	28
30	134	132	130	129	128	126	124	122	120	117	30
32	122	120	118	116	115	113	111	109	107	104	32
34	111	109	107	105	104	102	100	98	96	92	34
36	102	100	97	95	94	92	90	88	86	82	36
38	94	91	89	87	86	83	81	79	77	73	38
40		84	81	79	78	75	73	71	69	66	40
44		71	69	66	65	62	60	57	55	52	44
48			58	56	54	51	49	46	44	41	48
52				47	45	42	40	37	35	31	52
56				40	37	34	32	29	27	23	56
60					31	28	25	22	20	16	60
64						22	19	16	14	10	64
68						17	14	11	9	5	68
72							10	7			72

* nur aufrichtbar mit Derrickballast / raisable only with derrick ballast / seulement relevable avec contrepoids derrick

TAB 57387

Die Hubhöhen am SD-Auslegersystem. Lifting heights on SD boom/derrick combination. Hauteur de levage en configuration SD.

LR 1800

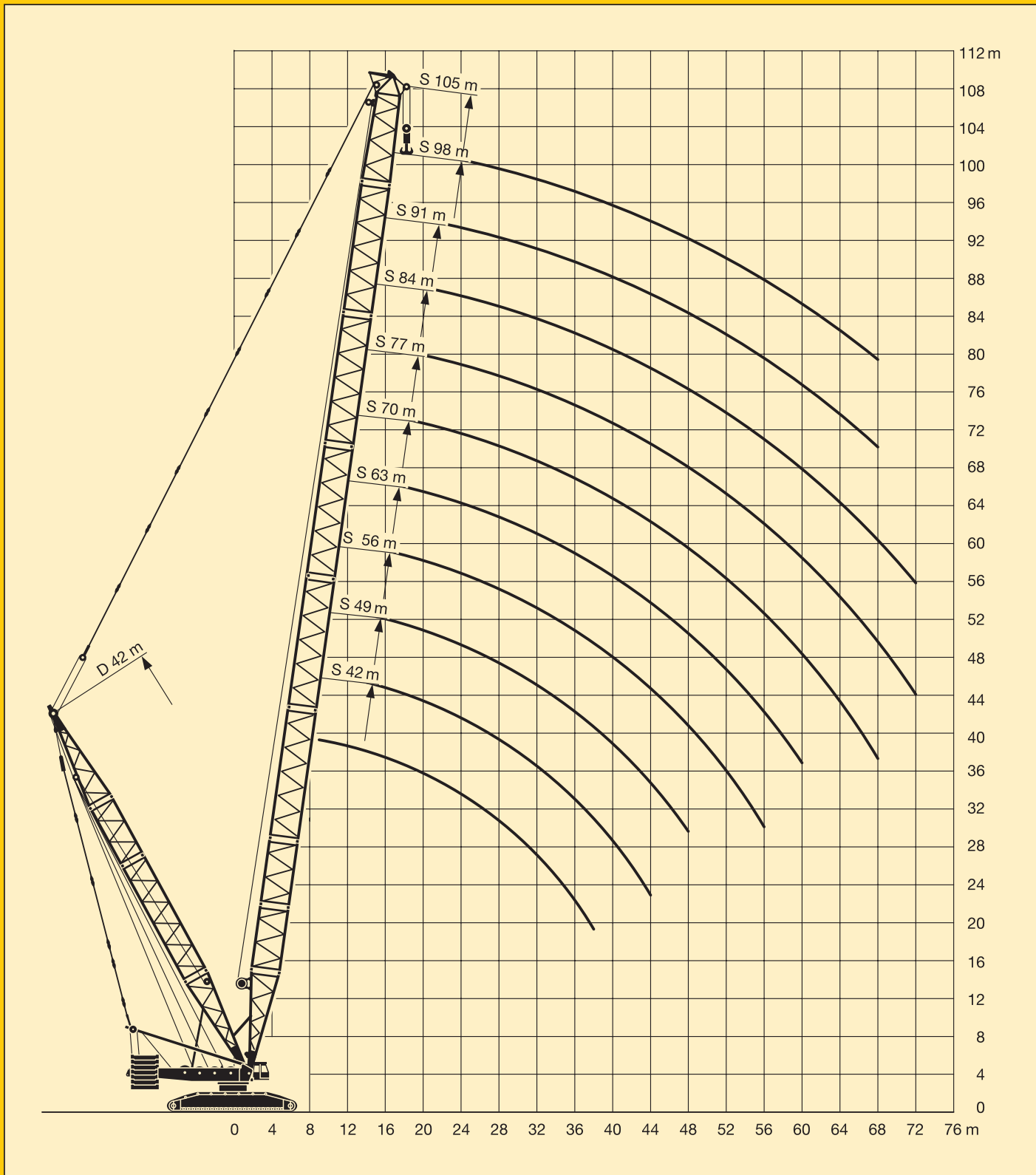

S 999

Die Traglasten am SDB/SDBW-Auslegersystem.

LR 1800

Lifting capacities on SDB/SDBW boom/derrick combination.

Forces de levage en configuration SDB/SDBW.



42 m –
126 m



35 m –
42 m



11,08 m
x
10,8 m



360°





162 t

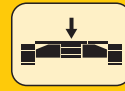

max.
450 t



32 t

 m	42 m	49 m	56 m	63 m	70 m	77 m	84 m	91 m	98 m	105 m	112 m	119 m	126 m	 m
9	800													9
10	760	710	628	596	547									10
11	720	695	620	584	536	506	438							11
12	690	680	612	573	526	498	434	410						12
14	660	650	596	550	505	482	426	400	370	358	330			14
16	630	620	580	527	484	466	418	390	360	346	326	291	254	16
18	600	598	564	502	463	450	410	380	350	334	322	286	248	18
20	580	572	539	479	444	434	405	370	340	322	311	279	242	20
22	550	548	516	458	426	416	391	360	330	310	300	272	236	22
24	498	515	494	438	409	400	375	350	320	298	289	265	230	24
26	445	475	470	420	394	384	359	340	308	286	278	258	224	26
28	399	435	432	404	380	370	344	330	296	278	268	251	218	28
30	359	405	400	385	365	355	330	316	284	264	258	245	212	30
32	323	370	372	360	345	332	314	296	272	253	245	238	206	32
34	291	349	346	333	320	308	294	276	256	242	237	230	200	34
36	262	324	324	312	300	288	274	258	244	232	228	220	195	36
38	234	304	302	290	280	268	254	240	232	222	218	211	189	38
40		283	284	274	263	252	242	230	222	214	209	203	183	40
44		234	254	244	234	225	218	210	203	196	192	187	171	44
48			227	222	213	205	199	192	186	180	176	173	160	48
52				203	196	190	184	178	172	166	162	161	147	52
56				185	183	177	170	163	156	150	146	150	135	56
60					172	164	156	148	144	138	132	139	123	60
64						150	142	137	132	128	124	130	113	64
68						136	130	125	120	116	112	122	103	68
72							122	117	112	108	104	112	93	72
76								109	104	100	96	102	84	76
80								101	96	92	88	92	75	80
84									89	85	81	81	70	84
88									82	78	74	74	65	88
92										72	68	67	61	92
96											60	60	57	96
100												54	53	100
104													50	104

TAB 57379

Die Traglasten am SDB/SDBW-Auslegersystem.

LR 1800

Lifting capacities on SDB/SDBW boom/derrick combination.

Forces de levage en configuration SDB/SDBW.



42 m –
126 m



35 m –
42 m



11,08 m
x
10,8 m



360°





238 t

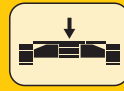

max.
450 t



142 t

 m	42 m	49 m	56 m	63 m	70 m	77 m	84 m	91 m	98 m	105 m	112 m	119 m	126 m	 m
9	800													9
10	800	800	800	730	683									10
11	800	800	800	710	666	603	536							11
12	800	800	773	688	650	598	532	472						12
14	774	766	731	649	617	587	523	465	414	369	330			14
16	733	726	692	615	584	575	515	458	407	364	326	291	259	16
18	695	689	658	583	554	545	505	452	402	358	322	287	256	18
20	637	656	626	555	527	518	480	446	397	354	317	283	253	20
22	561	626	597	529	502	494	457	439	392	349	314	280	250	22
24	498	567	571	505	479	471	435	428	386	345	310	277	248	24
26	445	515	523	483	458	450	416	408	380	340	305	273	245	26
28	399	471	478	463	438	431	398	390	374	336	300	269	242	28
30	359	435	439	444	420	413	381	374	358	332	296	265	238	30
32	323	402	406	411	404	396	365	358	343	328	291	262	235	32
34	291	372	379	381	387	381	351	344	329	322	284	258	232	34
36	262	340	353	357	361	358	337	331	316	310	277	255	229	36
38	234	310	331	333	337	334	325	318	304	297	270	252	226	38
40		283	310	315	317	313	313	306	292	286	263	249	224	40
44		234	268	280	281	279	276	274	271	265	248	244	219	44
48			227	248	252	250	249	246	242	238	232	230	214	48
52				216	229	230	229	227	217	213	211	209	199	52
56				185	203	211	210	209	201	191	189	187	169	56
60					177	188	193	192	185	173	171	168	141	60
64						166	173	175	172	159	155	151	120	64
68						145	155	158	158	148	141	138	103	68
72							137	142	144	137	128	125	93	72
76								127	131	127	117	112	84	76
80								113	118	117	106	99	75	80
84									105	107	97	91	70	84
88									93	96	89	85	65	88
92										85	82	78	61	92
96											71	72	57	96
100												65	53	100
104													50	104

TAB 57380

Die Hubhöhen am SDB/SDBW-Auslegersystem.
Lifting heights on SDB/SDBW boom/derrick combination.
Hauteur de levage en configuration SDB/SDBW.

LR 1800

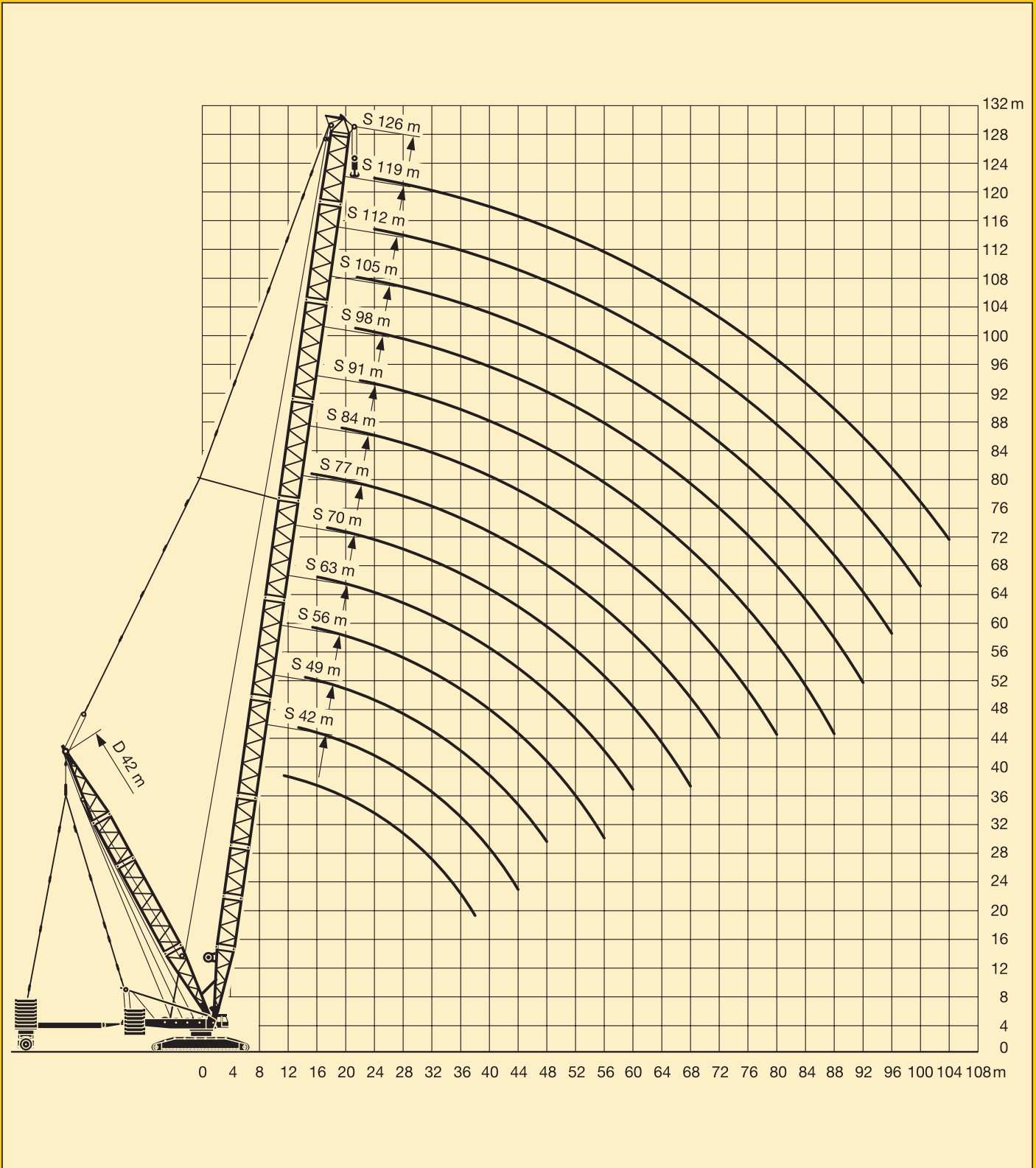

S 997

Die Traglasten am SDW-Auslegersystem. Lifting capacities on SDW boom/derrick/jib combination. Forces de levage en configuration SDW.

LR 1800



88°
49 m -
70 m



42 m



35 m -
91 m

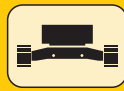

11,08 m
x
10,8 m



360°



238 t

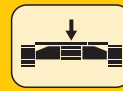

142 t

m	49 m									56 m									m		
	35 m	42 m	49 m	56 m	63 m	70 m	77 m	84 m	91 m	35 m	42 m	49 m	56 m	63 m	70 m	77 m	84 m	91 m			
14	350	348								344	342									14	
16	306	304	302							300	299	297									16
18	271	269	268	266						266	265	263	261								18
20	243	241	240	238	236					238	237	235	234	232							20
22	219	218	216	215	213	207	180			215	214	212	211	209	207	180					22
24	199	198	197	196	194	192	176	150		196	195	193	192	190	189	176	150				24
26	183	182	180	179	178	176	172	147	135	179	178	177	175	174	173	171	147	130			26
28	168	167	166	165	163	162	160	143	131	165	164	163	160	160	159	157	143	125			28
30	155	154	153	152	151	149	148	140	126	152	151	150	148	148	146	145	140	120			30
32	143	143	142	140	139	138	136	135	123	140	140	139	137	137	135	133	131	116			32
34	133	132	131	130	129	128	126	125	118	130	130	129	127	127	125	123	121	112			34
36		123	122	121	120	119	117	116	113	121	121	120	118	118	117	114	113	108			36
38		115	114	113	112	111	109	108	105		113	112	110	110	108	106	105	102			38
40		108	107	106	105	104	102	100	97		106	105	103	103	101	99	97	94			40
44			95	94	93	91	89	87	85		93	93	91	91	89	86	84	82			44
48			84	83	82	81	78	76	74			82	81	80	78	76	74	71			48
52				74	73	72	70	67	65				72	72	70	67	65	62			52
56					66	64	62	60	57				65	65	62	60	58	55			56
60					59	58	56	54	51					58	56	54	52	49,5			60
64					52	50	48,5	46						52	51	48,5	46,5	44			64
68						46,5	45	43,5	41						45,5	44	42	39,5			68
72							40,5	39,5	37							39,5	38	35			72
76							36	35	33							35,5	34	31,5			76
80								31,5	29,5								30,5	28,4			80
84								28	26,1								27,4	25,5			84
88									23									22,5			88

TAB 57270.1

m	63 m									70 m									m			
	35 m	42 m	49 m	56 m	63 m	70 m	77 m	84 m	91 m	35 m	42 m	49 m	56 m	63 m	70 m	77 m	84 m	91 m				
16	298	296								296	293										16	
18	265	262	260							262	260	258										18
20	237	235	233	232	225					235	233	231	229	215								20
22	214	212	211	209	207	192	168			212	210	209	207	205	180	160						22
24	195	193	192	190	188	187	164	144		193	191	190	188	186	176	156	138					24
26	178	177	175	174	172	171	160	140	125	177	175	174	172	170	169	152	135					26
28	164	163	161	160	159	157	155	136	120	163	161	160	159	157	155	148	132	116				28
30	152	150	149	148	146	145	143	133	115	151	149	148	146	145	143	141	128	110				30
32	140	139	138	137	135	134	133	130	110	139	138	137	136	134	133	131	125	106				32
34	130	129	128	127	125	124	123	121	106	129	128	127	126	124	123	121	119	101				34
36	121	120	119	118	117	116	114	113	102	121	119	118	117	116	114	112	111	97				36
38		112	111	110	109	108	106	105	98		111	110	109	108	107	105	103	93				38
40		105	104	103	102	101	99	98	95		104	103	102	101	100	98	96	90				40
44		93	92	91	90	89	87	86	83		92	91	90	89	88	86	84	81				44
48			82	81	80	79	77	75	73			81	80	79	78	75	73	71				48
52				73	71	70	68	66	63				72	70	69	67	64	62				52
56					65	64	63	61	59	64			64	63	62	60	57	55				56
60						58	56	55	52	50				57	56	53	51	48,5				60
64						52	51	49	47	44,5					51	50	48	45,5				64
68							45,5	44,5	42,5	40						45,5	43	41	38,5			68
72							41	40	38	35,5					41	39	37	34,5				72
76								35,5	34	32						35,5	31	33,5				76
80									30,5	28,7							30	27,6				80
84									27,1	25,3							26,8	24,7				84
88										22,2								21,9				88
92																		21,2				92

TAB 57270.2

Fortsetzung

Die Traglasten am SDW-Auslegersystem. Lifting capacities on SDW boom/derrick/jib combination. Forces de levage en configuration SDW.

LR 1800



88°
77 m -
91 m



42 m



35 m -
91 m



11,08 m
x
10,8 m



360°



238 t

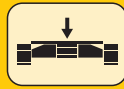

142 t

m	77 m										84 m										m
	35 m	42 m	49 m	56 m	63 m	70 m	77 m	84 m	91 m	35 m	42 m	49 m	56 m	63 m	70 m	77 m	84 m	91 m			
16	292	280								275	245									16	
18	259	257	245							256	238	215								18	
20	232	231	228	210	185					230	228	209	185	165						20	
22	210	208	206	204	180	160				208	206	203	180	160	145					22	
24	191	190	188	186	176	156	138			189	188	186	175	156	141	125				24	
26	175	174	172	170	169	151	135	120		173	172	170	169	152	137	121	110			26	
28	161	160	158	157	155	147	131	117	110	160	159	157	155	148	133	118	106	100		28	
30	149	148	146	145	143	142	127	114	105	148	147	144	142	142	129	114	103	96		30	
32	138	137	136	133	133	131	124	111	100	137	136	134	132	131	126	111	100	93		32	
34	128	127	126	124	123	122	120	108	96	127	126	124	122	122	120	108	97	90		34	
36	119	119	117	115	115	113	111	105	92	118	118	115	113	114	112	104	94	87		36	
38		111	110	107	107	105	104	102	88		110	107	106	106	104	101	92	84		38	
40		104	103	100	100	99	97	95	85		103	101	99	99	98	95	89	80		40	
44		92	91	89	88	87	84	82	79		91	89	87	87	85	83	81	76		44	
48			80	79	78	76	74	72	69			79	77	77	75	73	70	68		48	
52				70	70	68	65	63	60			71	69	69	66	64	62	59		52	
56				63	63	61	58	56	53				62	62	59	57	54	52		56	
60					57	55	52	49,5	47					56	53	51	48	45,5		60	
64					51	49,5	46,5	44,5	41,5					50	48	45,5	43	40		64	
68						44,5	42	40	37					43,5	41	38,5	36	36		68	
72						41	38	36	33,5					40	37	34,5	32	32		72	
76							34,5	32,5	29,7						33,5	31,5	28,5	28,5		76	
80								29,2	26,6							28,2	25,5	25,5		80	
84								26,4	23,8							25,5	22,8	22,8		84	
88									21,4								20,4	20,4		88	
92									19,2								18,3	18,3		92	

TAB 57270.3

m	91 m										m
	35 m	42 m	49 m	56 m	63 m	70 m	77 m	84 m	91 m		
16	250	215									16
18	242	210	190								18
20	227	204	185	165	150						20
22	205	199	180	161	146	130					22
24	187	186	176	157	142	126	115				24
26	171	170	168	153	139	123	112	100			26
28	158	157	154	149	136	120	109	98	90		28
30	146	145	141	139	133	117	106	95	88		30
32	136	134	131	129	129	114	103	93	85		32
34	126	124	121	119	120	111	100	90	83		34
36	117	116	113	111	112	108	98	88	80		36
38	109	108	105	103	105	103	95	85	78		38
40		101	98	97	98	96	92	83	75		40
44		90	87	85	86	84	81	78	71		44
48			77	75	76	74	71	68	66		48
52			70	67	67	65	62	60	57		52
56				61	60	58	55	52	49,5		56
60					54	52	49	46,5	43,5		60
64					49,5	47	44	41,5	38,5		64
68						42,5	39,5	37	34		68
72						38,5	36	33,5	30,5		72
76							32,5	29,9	27,1		76
80								26,9	24,2		80
84								24,3	21,6		84
88									19,2		88
92									17,2		92

TAB 57270.4

Die Hubhöhen am SDW-Auslegersystem. Lifting heights on SDW boom/derrick/jib combination. Hauteur de levage en configuration SDW.

LR 1800

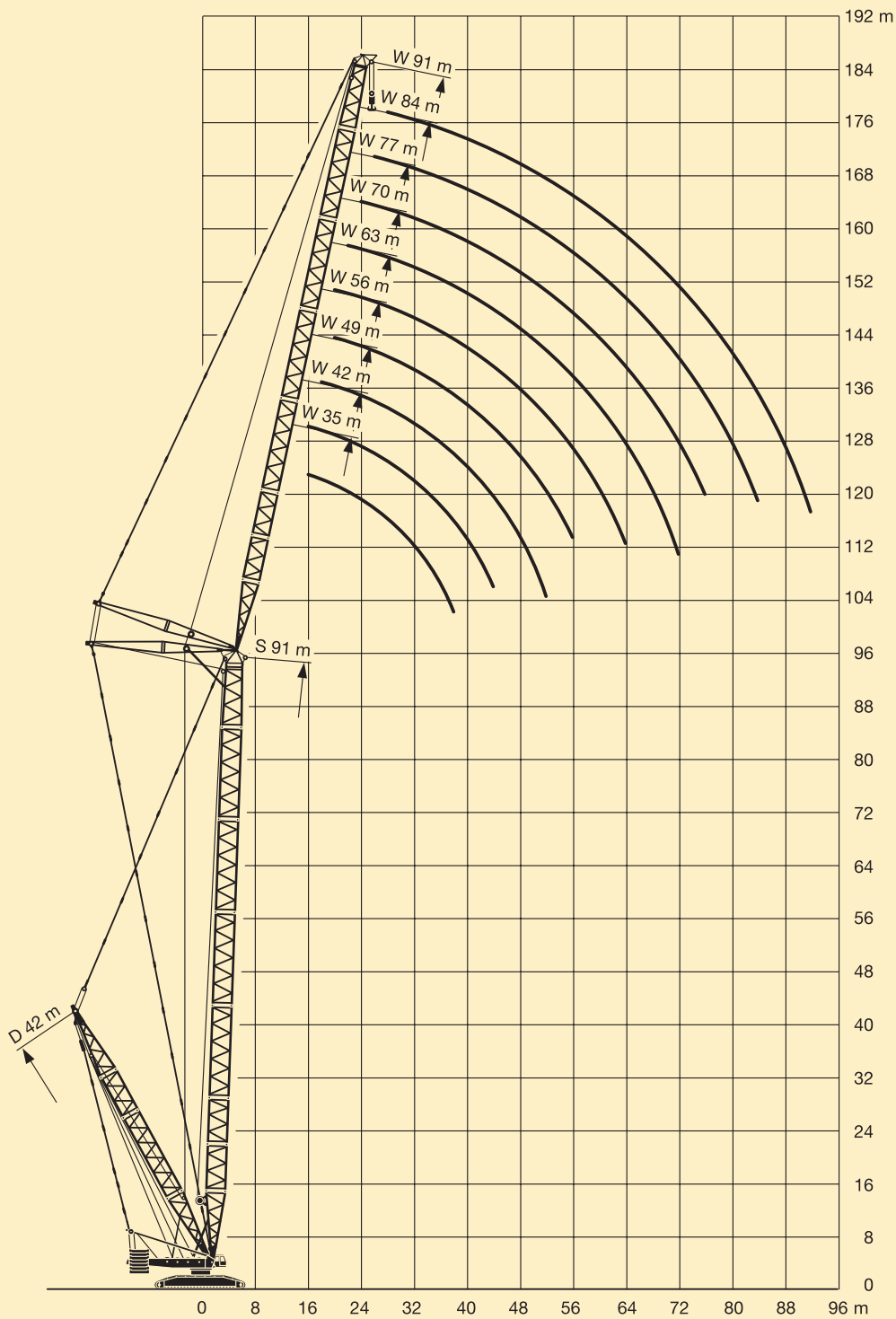

S-Ausleger / S boom / Flèche principale S: 88°.

S 1011

Die Traglasten am SDWB/SDWBW-Auslegersystem. Lifting capacities on SDWB/SDWBW combination. Forces de levage en configuration SDWB/SDWBW.

LR 1800



88°
49 m –
70 m



42 m



35 m –
91 m



11,08 m
x
10,8 m



360°



162 t

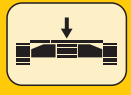

32 t

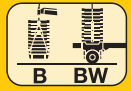

350 t

m	49 m									56 m									m
	35 m	42 m	49 m	56 m	63 m	70 m	77 m	84 m	91 m	35 m	42 m	49 m	56 m	63 m	70 m	77 m	84 m	91 m	
14	469	408								450	400								14
16	458	406	355							440	390	340							16
18	435	398	349	302						420	378	335	290						18
20	414	378	343	297	260					398	360	325	282	243					20
22	395	360	331	290	254	221	191			379	344	315	275	237	207	180			22
24	377	343	316	282	248	216	187	162		361	330	300	264	232	202	176	153		24
26	344	328	302	274	241	211	183	159	137	345	318	286	255	226	198	172	150	132	26
28	312	313	290	266	235	206	179	156	135	315	306	275	247	221	194	169	147	130	28
30	286	296	278	258	228	202	175	153	132	288	292	266	239	215	190	165	144	127	30
32	264	272	267	251	221	197	171	149	129	266	274	257	232	209	185	162	141	123	32
34	243	251	257	244	215	190	167	145	125	245	253	248	225	203	180	158	138	120	34
36		235	239	236	209	184	161	141	122	227	236	238	218	198	175	154	135	117	36
38		219	222	223	202	179	156	136	118		220	223	211	193	170	149	130	113	38
40		205	208	208	195	173	151	131	113		206	209	204	187	165	144	126	109	40
44			185	184	180	161	141	121	104		180	186	186	175	155	136	117	101	44
48			164	164	162	150	131	113	95			165	166	163	145	127	109	93	48
52				147	146	139	121	104	88				149	148	135	118	102	86	52
56					132	129	112	96	80				133	134	126	110	95	79	56
60					119	119	104	89	74					121	118	103	89	72	60
64						108	97	82	67					106	109	95	82	66	64
68						98	90	77	62						99	89	77	61	68
72							84	71	56							83	71	56	72
76							78	66	52							79	66	51	76
80								60	47								60	47	80
84								57	43								57	42	84
88									40									39	88

TAB 57419.1

m	63 m									70 m									m
	35 m	42 m	49 m	56 m	63 m	70 m	77 m	84 m	91 m	35 m	42 m	49 m	56 m	63 m	70 m	77 m	84 m	91 m	
16	393	350								351	320								16
18	382	342	305							340	312	280							18
20	368	330	298	260	227					327	305	271	240	215					20
22	353	317	286	252	222	194	169			314	294	262	233	209	180	160			22
24	339	305	275	246	218	190	165	146		303	284	254	226	204	177	156	138		24
26	325	294	268	240	213	187	162	143	125	291	274	245	219	199	174	153	135		26
28	312	283	255	233	208	182	159	141	122	279	264	237	213	194	170	150	132	116	28
30	294	272	247	225	203	178	156	138	120	269	254	228	205	188	167	147	130	113	30
32	271	262	239	219	197	175	153	135	117	259	244	220	199	184	163	144	127	111	32
34	250	251	231	212	192	170	150	132	114	249	235	212	192	179	159	141	124	108	34
36	231	239	222	206	187	166	146	129	111	235	223	204	186	175	156	138	121	105	36
38		223	215	199	183	161	141	125	108		212	196	183	171	152	134	118	103	38
40		208	207	193	178	157	137	120	105		205	189	177	167	148	130	115	100	40
44		184	186	182	168	149	129	113	97		186	177	164	157	141	123	108	93	44
48			165	170	158	140	122	105	90			165	154	148	133	117	101	87	48
52				155	149	131	114	98	83				145	140	126	110	95	81	52
56				140	138	123	106	92	77				136	133	118	103	88	75	56
60					125	115	99	85	71					125	112	96	83	69	60
64					113	108	92	79	65					115	105	90	77	64	64
68						102	86	73	59						100	85	72	59	68
72						86	81	68	55						89	79	66	54	72
76							77	63	50							76	61	50	76
80								58	46								57	46	80
84								56	42								55	42	84
88									39									39	88
92																		37	92

TAB 57419.2

Fortsetzung

Die Traglasten am SDWB/SDWBW-Auslegersystem. Lifting capacities on SDWB/SDWBW combination. Forces de levage en configuration SDWB/SDWBW.

LR 1800

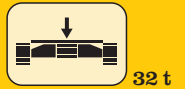

32 t



88°
77 m –
91 m



42 m



35 m –
91 m



11,08 m
x
10,8 m



360°



162 t

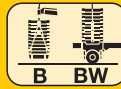

350 t

m	77 m									84 m									m		
	35 m	42 m	49 m	56 m	63 m	70 m	77 m	84 m	91 m	35 m	42 m	49 m	56 m	63 m	70 m	77 m	84 m	91 m			
16	311	280								276	245									16	
18	301	273	245							269	239	215									18
20	292	265	237	210	193					262	232	209	186	174							20
22	284	258	229	204	190	167				253	225	203	182	171	153						22
24	274	250	222	198	186	164	145			244	218	198	178	168	150	133					24
26	264	242	214	193	182	161	143	124		236	211	192	173	164	147	131	116				26
28	254	234	208	187	178	158	141	122	110	228	205	186	169	160	144	129	114	100			28
30	244	225	200	182	174	155	138	120	106	219	198	180	164	156	141	126	113	98			30
32	233	217	194	176	169	152	135	118	104	210	192	175	159	152	138	124	110	97			32
34	225	208	188	171	164	148	132	116	102	203	185	170	155	148	135	121	108	95			34
36	218	200	182	167	160	144	129	113	99	196	179	164	151	144	131	119	106	93			36
38		192	176	161	156	141	126	111	97		174	159	146	140	128	116	104	91			38
40		186	171	156	152	137	123	108	95		168	154	142	137	125	113	101	89			40
44		178	161	147	143	130	117	102	89		161	146	134	129	119	107	97	84			44
48			151	139	135	123	111	96	83			137	126	122	112	102	92	79			48
52				131	128	117	105	91	78			133	119	116	106	97	87	74			52
56				126	121	111	99	85	72				114	110	101	92	81	69			56
60					115	105	93	79	67					104	96	87	76	64			60
64					110	100	88	74	62					101	91	83	72	60			64
68						95	82	70	57						87	79	67	55			68
72						88	77	65	53						83	75	63	51			72
76							74	60	48							71	59	47			76
80								56	45								55	43			80
84								54	41								53	40			84
88									38									37			88
92									36									36			92

TAB 57419.3

m	91 m									m
	35 m	42 m	49 m	56 m	63 m	70 m	77 m	84 m	91 m	
16	250	215								16
18	242	212	190							18
20	233	207	186	165	156					20
22	226	201	182	162	154	137				22
24	219	195	177	158	151	134	120			24
26	212	189	172	154	148	132	118	104		26
28	205	183	167	151	145	129	116	103	90	28
30	199	178	162	146	141	127	114	101	89	30
32	193	173	158	142	138	124	112	99	88	32
34	186	168	153	138	134	121	110	97	86	34
36	181	163	149	135	130	118	107	96	85	36
38	176	159	144	131	127	115	104	94	83	38
40		153	140	128	124	112	102	91	81	40
44		145	132	120	117	106	97	87	78	44
48			125	114	111	101	93	83	74	48
52			121	107	105	96	88	79	70	52
56				103	100	91	83	75	66	56
60					95	86	79	71	61	60
64					91	82	75	68	57	64
68						78	72	64	53	68
72						76	68	61	49	72
76							66	57	45	76
80								53	42	80
84								51	39	84
88									36	88
92									35	92

TAB 57419.4

Die Hubhöhen am SDWB/SDWBW-Auslegersystem. Lifting heights on SDWB/SDWBW combination. Hauteur de levage en configuration SDWB/SDWBW.

LR 1800

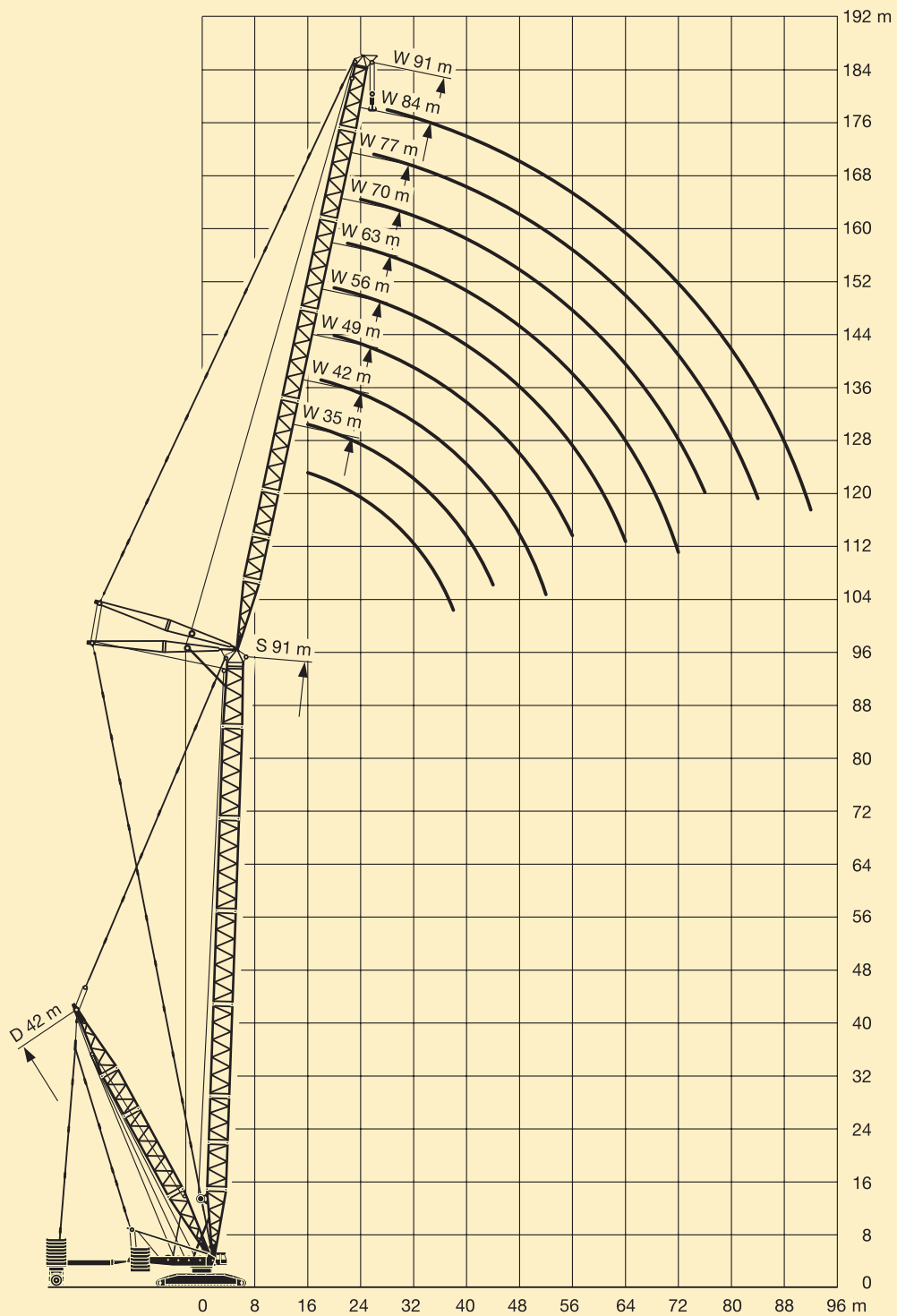

S-Ausleger / S boom / Flèche principale S: 88°.

S 993

Die Traglasten am SDWB/SDWBW-Auslegersystem. Lifting capacities on SDWB/SDWBW combination. Forces de levage en configuration SDWB/SDWBW.

LR 1800



82°
98 m –
105 m



42 m



42 m –
56 m



11,08 m
x
10,8 m



360°



162 t

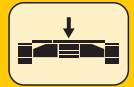

32 t

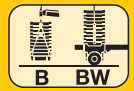

max.
250 t

m	98 m			105 m			m
	42 m	49 m	56 m	42 m	49 m	56 m	
32	165						32
34	162	154		152	142		34
36	158	151	138	150	141		36
38	155	149	136	146	140	129	38
40	153	146	134	144	138	127	40
44	147	141	130	139	133	122	44
48	141	135	125	133	128	117	48
52	136	130	121	128	121	111	52
56	128	125	118	123	114	105	56
60		115	112		108	100	60
64			103		102	94	64
68						90	68

TAB 57397

Die Hubhöhen am SDWB/SDWBW-Auslegersystem. Lifting heights on SDWB/SDWBW combination. Hauteur de levage en configuration SDWB/SDWBW.

LR 1800

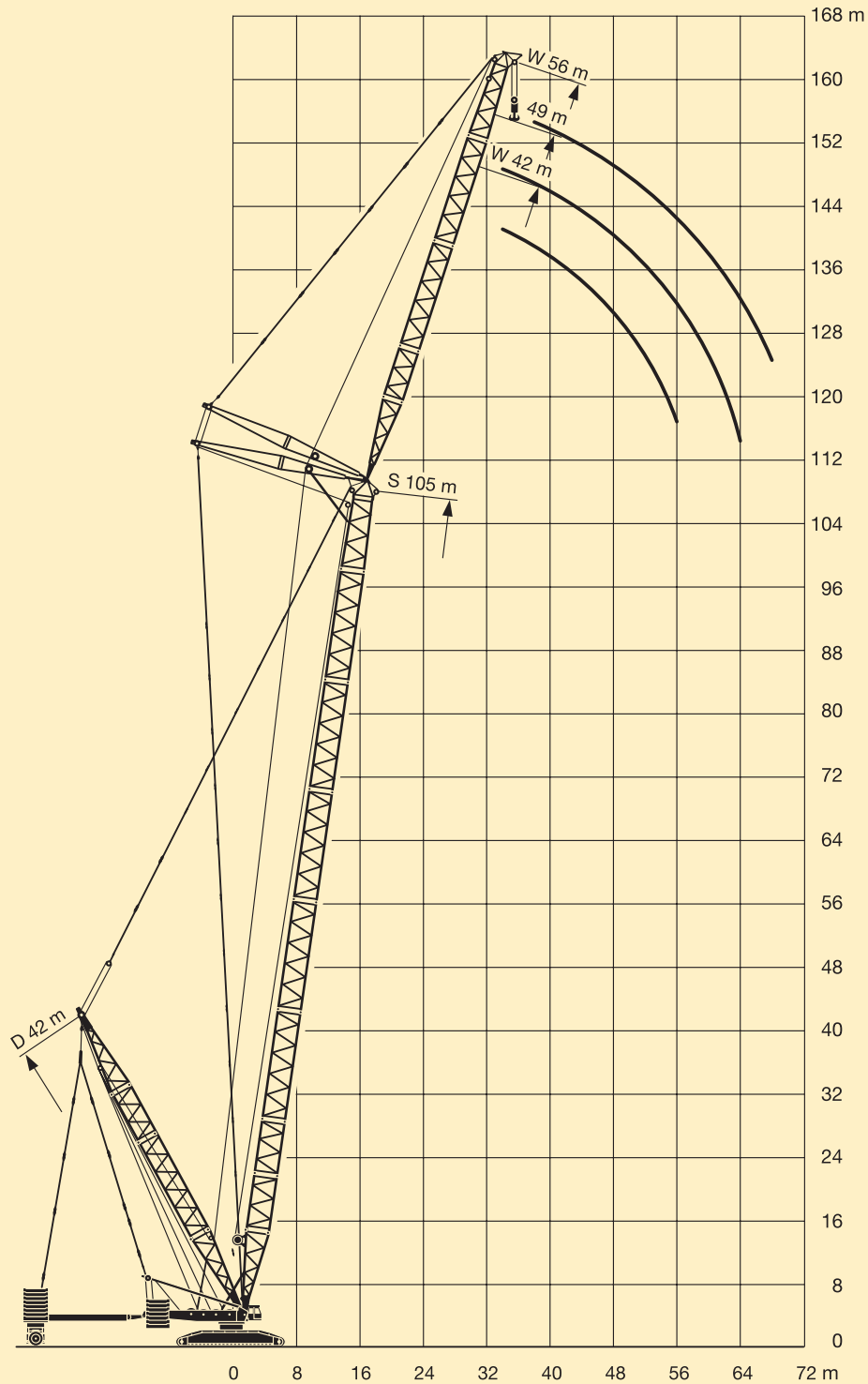

S-Ausleger / S boom / Flèche principale S: 82°.

S 995

Die Traglasten am SDWB/SDWBW-Auslegersystem. Lifting capacities on SDWB/SDWBW combination. Forces de levage en configuration SDWB/SDWBW.

LR 1800



70°
49 m –
70 m



42 m



35 m –
91 m



11,08 m
x
10,8 m



360°



162 t

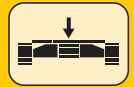

32 t

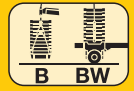

max.
450 t

m	49 m									56 m									m	
	35 m	42 m	49 m	56 m	63 m	70 m	77 m	84 m	91 m	35 m	42 m	49 m	56 m	63 m	70 m	77 m	84 m	91 m		
40	252																			40
44	236	234								223										44
48	222	220	217							209	207									48
52	209	207	204	202						197	195	192								52
56		196	193	191	185					186	184	181	179							56
60		175	177	175	173	154					174	172	170	170						60
64			157	157	156	148	125					163	161	161	145					64
68			132	142	141	139	119	99				153	152	150	138	117				68
72				129	128	126	113	94	75				137	136	131	111	93			72
76					116	115	106	88	71				121	124	123	104	87	70		76
80					106	105	100	83	66					113	112	98	82	66		80
84						97	94	78	62					97	102	92	77	62		84
88						84	87	72	57						94	85	71	57		88
92							81	67	53							79	66	53		92
96							66	62	48,5							73	61	48,5		96
100								56	44								55	44		100
104									40								50	39,5		104
108									35,5									35,5		108
112																		31		112

TAB 57291

m	63 m									70 m									m	
	35 m	42 m	49 m	56 m	63 m	70 m	77 m	84 m	91 m	35 m	42 m	49 m	56 m	63 m	70 m	77 m	84 m	91 m		
44	211																			44
48	198	196								193										48
52	186	184	181							181	181									52
56	176	173	171	172						171	171	168								56
60		164	161	162	162					161	162	159	160							60
64		156	153	154	153	142					153	150	151	148						64
68			145	146	145	136	115				145	143	143	140	130					68
72			138	139	138	129	109	91				136	136	133	125	108				72
76				132	131	122	102	86	70				130	127	119	103	86			76
80					123	115	96	81	66				124	121	114	98	81	65		80
84					109	109	90	75	61					115	108	93	77	62		84
88						101	83	70	57					101	103	88	73	58		88
92							87	77	65	53					96	83	69	54		92
96								70	59	48,5					79	78	64	51		96
100								64	54	44						73	60	47		100
104									48,5	39,5							56	43,5		104
108										35,5							51	39,5		108
112										31								36		112
116																		32,5		116

TAB 57291

Die Traglasten am SDWB/SDWBW-Auslegersystem. Lifting capacities on SDWB/SDWBW combination. Forces de levage en configuration SDWB/SDWBW.

LR 1800



70°
77 m –
105 m



42 m



35 m –
91 m



11,08 m
x
10,8 m



360°



162 t

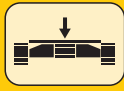

32 t

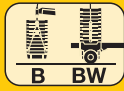

max.
450 t

m	77 m										84 m										m
	35 m	42 m	49 m	56 m	63 m	70 m	77 m	84 m	91 m	35 m	42 m	49 m	56 m	63 m	70 m	77 m	84 m	91 m			
52	170									164										52	
56	161	159								155	158									56	
60	152	150	151							146	149	149								60	
64		142	143	141						138	141	141	139							64	
68		135	136	134	133						134	133	131	124						68	
72			129	127	127	121					127	127	125	120	108					72	
76			122	121	120	117	103	86				120	119	116	104	93				76	
80				115	114	112	99	82	65			114	113	112	101	90	77			80	
84				110	109	108	96	79	62				108	107	97	87	74	60		84	
88					104	104	92	76	59					102	94	84	71	57		88	
92						99	89	72	56					97	90	81	68	54		92	
96						91	85	69	53						87	79	65	51		96	
100							82	66	50						83	76	62	48		100	
104							74	63	47							73	59	45		104	
108								59	44							66	56	41,5		108	
112								56	41								53	38,5		112	
116									38									35,5		116	
120																		32,5		120	

TAB 57291

m	91 m										98 m			105 m			m			
	35 m	42 m	49 m	56 m	63 m	70 m	77 m	84 m	91 m	42 m	49 m	56 m	42 m	49 m	56 m					
56	143																			56
60	135	140																		60
64	128	133	129										130	115			108			64
68	121	126	122	119									125	111	100		104	95		68
72		119	116	115	105								120	107	97		99	91	82	72
76			110	111	102	92							115	104	93		95	88	79	76
80			105	106	98	90	81	71						100	90	90	84	76		80
84				101	95	87	79	68	58					96	87		80	74		84
88				96	92	84	76	66	55						83			71		88
92					88	81	74	63	52									68		92
96					85	78	72	60	48,5											96
100						76	70	58	45,5											100
104							67	55	42,5											104
108							65	52	39,5											108
112								49,5	36,5											112
116								47	33											116
120									30											120
124									27											124

TAB 57291

Die Hubhöhen am SDWB/SDWBW-Auslegersystem.
Lifting heights on SDWB/SDWBW combination.
Hauteur de levage en configuration SDWB/SDWBW.

LR 1800

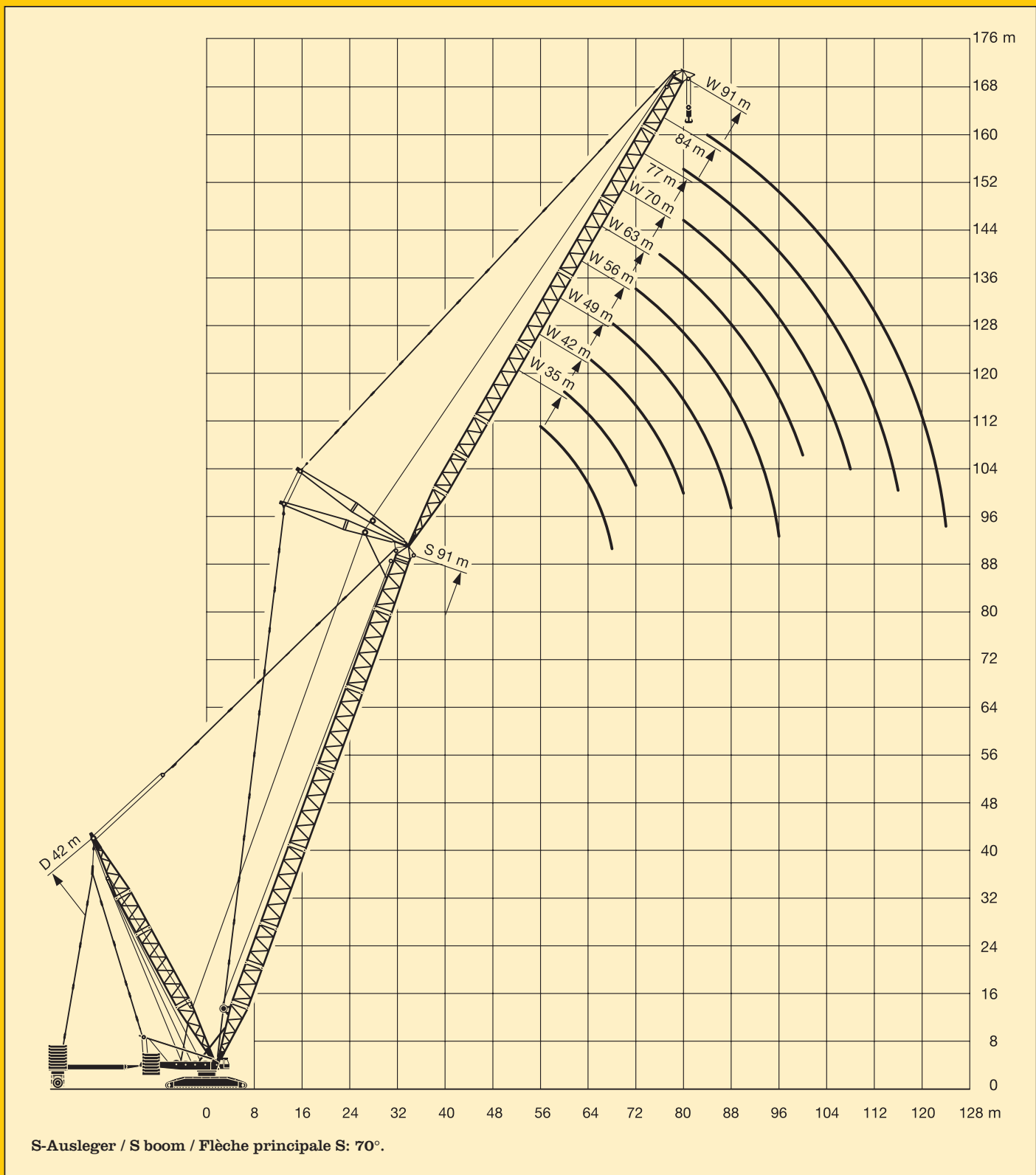

S 994

Die Traglasten am SDWVBW-Auslegersystem. Lifting capacities on SDWVBW combination. Forces de levage en configuration SDWVBW.

LR 1800



49 m -
91 m



42 m



18°
21 m



360°



162 t

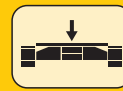

32 t

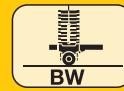

max.
450 t
x 25 m

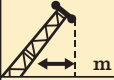
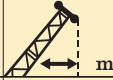
 m	49 m	56 m	63 m	70 m	77 m	84 m	91 m	 m
18	550	550						18
20	541	526	466	418	381			20
22	517	505	448	402	366	314	272	22
24	496	485	431	387	353	302	262	24
26	464	458	416	374	341	291	252	26
28	431	424	401	361	329	281	244	28
30	402	396	388	348	318	272	235	30
32	376	371	367	337	307	263	228	32
34	353	348	343	326	298	254	220	34
36	332	326	323	316	289	246	213	36
38	308	302	304	300	280	239	207	38
40	287	281	287	282	272	232	201	40
44	252	245	253	251	247	219	190	44
48	221	216	222	225	222	208	180	48
52	196	191	197	199	200	196	171	52
56	168	170	175	177	177	176	163	56
60	142	151	156	157	158	160	156	60
64	117	135	139	140	141	144	141	64
68		115	124	126	125	129	128	68
72		91	110	112	112	115	116	72
76			92	101	100	103	103	76
80				87	89	91	92	80
84				70	79	81	82	84
88					68	72	72	88
92						62	64	92
96						50	55	96
100							45	100

TAB 57427

Die Hubhöhen am SDWVBW-Auslegersystem. Lifting heights on SDWVBW combination. Hauteur de levage en configuration SDWVBW.

LR 1800

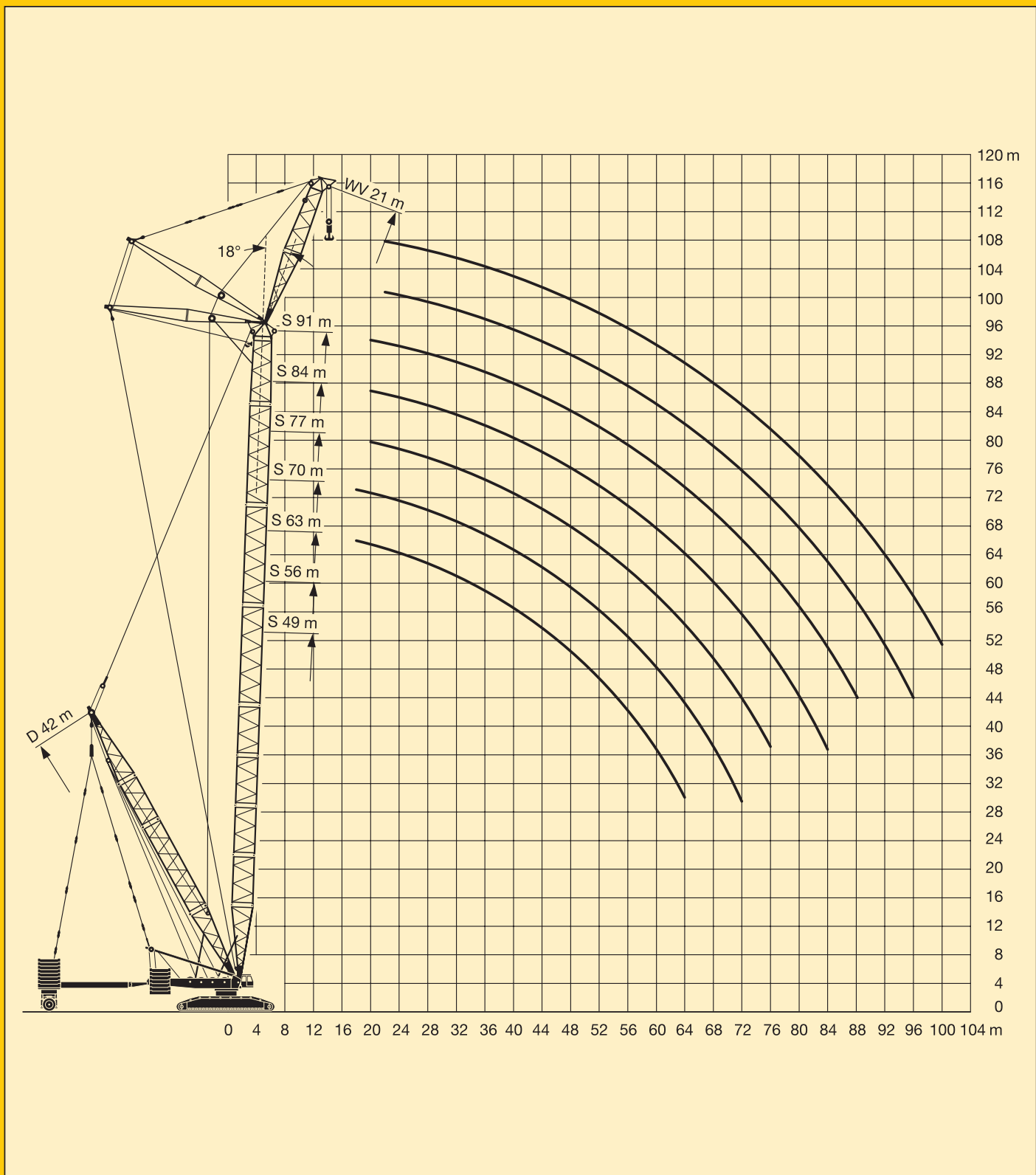

S 1020



Änderungen vorbehalten. / Subject to modification. / Sous réserve de modifications.

TP 353.07.03

Nehmen Sie Kontakt auf mit
Please contact
Veillez prendre contact avec
LIEBHERR-WERK EHINGEN GMBH
D-89582 Ehingen/Donau, ☎+49 (0) 73 91 5 02-0, Telefax +49 (0) 73 91 5 02-33 99
www.liebherr.com, E-mail: info@lwe.liebherr.com

CD-